

DOCUMENT RELEASE AND CHANGE FORM			Release Stamp	
Prepared For the U.S. Department of Energy, Assistant Secretary for Environmental Management By Hanford Tank Waste Operations & Closure LLC, (H2C) Contractor For U.S. Department of Energy, Hanford Field Office TRADEMARK DISCLAIMER: Reference herein to any specific commercial product, process, or service by trade name, trademark, manufacturer, or otherwise, does not necessarily constitute or imply its endorsement, recommendation, or favoring by the United States government or any agency thereof or its contractors or subcontractors. Printed in the United States of America.			<div style="border: 2px solid red; padding: 10px; display: inline-block;"> <p style="color: red; font-weight: bold; font-size: 1.2em;">DATE:</p> <p style="color: red; font-weight: bold; font-size: 1.5em;">Apr 28, 2025</p>  </div> <p style="color: red; font-weight: bold; font-size: 1.2em;">Clearance Review Restriction Type:</p> <p style="color: red; font-weight: bold;">Approved for Public Release</p>	
1. Doc No: HNF-EP-0182 Rev. 447				
2. Title: Waste Tank Summary Report for Month Ending March31, 2025				
3. Project Number: <input checked="" type="checkbox"/> N/A	4. Design Verification Required: <input type="checkbox"/> Yes <input checked="" type="checkbox"/> No			
5. USQ Number: <input checked="" type="checkbox"/> N/A RPP-27195	6. PrHA Number Rev. <input checked="" type="checkbox"/> N/A			
7. Approvals				
Title	Name	Signature	Date	
Clearance Review	Molina, Susan N	<i>Molina, Susan N</i>	04/28/2025	
Document Control Approval	Sandoval, Sierra D	<i>Sandoval, Sierra D</i>	04/23/2025	
Originator	Rodgers, Matt J	<i>Rodgers, Matt J</i>	04/23/2025	
Other Approver	McGrath, Markus H	<i>McGrath, Markus H</i>	04/23/2025	
Other Approver	Piepenbring, Ben R	<i>Piepenbring, Ben R</i>	04/23/2025	
Other Approver	Campbell, Shawn T	<i>Campbell, Shawn T</i>	04/23/2025	
Responsible Manager	Judkins, Elizha B	<i>Judkins, Elizha B</i>	04/23/2025	
8. Description of Change and Justification Complete Revision – Tables and text updated each month to reflect revised status. DOE-HFO requires this document to be revised and issued monthly.				
9. TBDs or Holds <input checked="" type="checkbox"/> N/A				
10. Related Structures, Systems, and Components				
a. Related Building/Facilities <input checked="" type="checkbox"/> N/A		b. Related Systems <input checked="" type="checkbox"/> N/A		c. Related Equipment ID Nos. (EIN) <input checked="" type="checkbox"/> N/A
11. Impacted Documents – Engineering <input checked="" type="checkbox"/> N/A				
Document Number	Rev.	Title		
12. Impacted Documents (Outside SPF): N/A				
13. Related Documents <input checked="" type="checkbox"/> N/A				
Document Number	Rev.	Title		
14. Distribution				
Name		Organization		
Baide, Dan		ENGINEERING & INNOVATION		
Ball, Ryan		TANK WST INVENTORY & CHARACTE		
Baune, Heather L		PROCESS ENGINEERING		
Becerra, Bryan		TANK WST INVENTORY & CHARACTE		
Bottenus, Courtney L				
Campbell, Shawn T		TANK & PIPELINE INTEGRITY		
Garrard, Noah N		TANK WST INVENTORY & CHARACTE		
Hall, Bekah N		ENGINEERING & INNOVATION		
Hixson, Kim K		TANK WST INVENTORY & CHARACTE		
Jensen, Andy M		AMPS ENGINEERING		
Judkins, Elizha B		TANK WST INVENTORY & CHARACTE		
Kirch, Nick		ENGINEERING & INNOVATION		
McGrath, Markus H		TANK WST INVENTORY & CHARACTE		
Mendoza, Ruben E		DFLAW ENGINEERING		
Morley, Shannon M		TANK WST INVENTORY & CHARACTE		
Moser, Dave R		B/C/S/T AND U FARM COMPLEXES		
Murry, Wendy I		DOCUMENT CONTROL SERVICE		
Pelafique, Maisie M		TSCR ENGINEERING		
Piepenbring, Ben R		TANK & PIPELINE INTEGRITY		
Powell, Johnathan C		TANK WST INVENTORY & CHARACTE		

DOCUMENT RELEASE AND CHANGE FORM		Doc No: HNF-EP-0182 Rev. 447
14. Distribution		
Name	Organization	
Rodgers, Matt J	TANK WST INVENTORY & CHARACTE	
Russell, Rose M	PROCESS & INTEGRITY ENGINEERIN	
Stauffer, Leslie A	TANK WST INVENTORY & CHARACTE	
Szolomayer, Makenna L	TANK WST INVENTORY & CHARACTE	
Tannahill, Chris L	FUELS FACILITIES MAINTENANCE	
Tardiff, Benjamin M	TANK WST INVENTORY & CHARACTE	
Welsch, Kelly R	TANK WST INVENTORY & CHARACTE	

INFORMATION CLEARANCE REVIEW AND RELEASE APPROVAL

Part I: Background Information

Title: Waste Tank Summary Report for Month Ending March 31, 2025	Information Category: <input type="checkbox"/> Abstract <input type="checkbox"/> Journal Article <input type="checkbox"/> Summary <input type="checkbox"/> Internet <input type="checkbox"/> Visual Aid <input type="checkbox"/> Software <input type="checkbox"/> Full Paper <input checked="" type="checkbox"/> Report <input type="checkbox"/> Other _____
Publish to OSTI? <input type="checkbox"/> Yes <input checked="" type="checkbox"/> No	Trademark/Copyright "Right to Use" Information or Permission Documentation Yes NA <input type="checkbox"/> <input checked="" type="checkbox"/>
Document Number: HNF-EP-0182 Revision 447	Date: April 2025
Author: Rodgers, Matt J	

Part II: External/Public Presentation Information

Conference Name:	
Sponsoring Organization(s): N/A	
Date of Conference:	Conference Location:
Will Material be Handed Out? <input type="checkbox"/> Yes <input checked="" type="checkbox"/> No	Will Information be Published? <input type="checkbox"/> Yes <input checked="" type="checkbox"/> No <i>(If Yes, attach copy of Conference format instructions/guidance.)</i>

Part III: H2C Document Originator Checklist

Description	Yes	N/A	Print/Sign/Date
Information Product meets requirements in TFC-BSM-AD-C-01?	<input type="checkbox"/>	<input checked="" type="checkbox"/>	
Document Release Criteria in TFC-ENG-DESIGN-C-25 completed? (Attach checklist)	<input checked="" type="checkbox"/>	<input type="checkbox"/>	Rodgers, Matt J Approved - IDMS data file att. / 04/22/2025
If product contains pictures, safety review completed?	<input checked="" type="checkbox"/>	<input type="checkbox"/>	Roberts, Sheryl K Approved - IDMS data file att. / 04/21/2025

Part IV: H2C Internal Review

Function	Organization	Date	Print Name/Signature/Date
Subject Matter Expert	H2C	04/22/2025	Rodgers, Matt J Approved - IDMS data file att.
Responsible Manager	H2C	04/21/2025	Judkins, Elizha B Approved - IDMS data file att.
Other:			

Part V: IRM Clearance Services Review

Description	Yes	No	Print Name/Signature
Document Contains Classified Information?	<input type="checkbox"/>	<input checked="" type="checkbox"/>	If Answer is "Yes," ADC Approval Required _____ Print Name/Signature/Date
Document Contains Information Restricted by DOE Operational Security Guidelines?	<input type="checkbox"/>	<input checked="" type="checkbox"/>	Reviewer Signature: _____ Print Name/Signature/Date
Document is Subject to Release Restrictions? <i>If the answer is "Yes," please mark category at right and describe limitation or responsible organization below:</i>	<input type="checkbox"/>	<input checked="" type="checkbox"/>	Document contains: <input type="checkbox"/> Applied Technology <input type="checkbox"/> Protected CRADA <input type="checkbox"/> Personal/Private <input type="checkbox"/> Export Controlled <input type="checkbox"/> Proprietary <input type="checkbox"/> Procurement – Sensitive <input type="checkbox"/> Patentable Info. <input type="checkbox"/> OUO <input type="checkbox"/> Predecisional Info. <input type="checkbox"/> UCNi <input type="checkbox"/> Restricted by Operational Security Guidelines <input type="checkbox"/> Other (Specify) _____
Additional Comments from Information Clearance Specialist Review?	<input type="checkbox"/>	<input checked="" type="checkbox"/>	Information Clearance Specialist Approval <div style="border: 1px solid green; padding: 5px; display: inline-block; color: green; font-weight: bold;"> APPROVED By Sarah Harrison at 9:59 am, Apr 22, 2025 </div> _____ Print Name/Signature/Date

When IRM Clearance Review is Complete – Return to H2C Originator for Final Signature Routing (Part VI)

INFORMATION CLEARANCE REVIEW AND RELEASE APPROVAL

Part VI: Final Review and Approvals

Description	Approved for Release		Print Name/Signature	
	Yes	N/A		
H2C External Affairs	<input checked="" type="checkbox"/>	<input type="checkbox"/>	Kraemer, Kristin M	Approved - IDMS data file att.
H2C Office of Chief Counsel	<input checked="" type="checkbox"/>	<input type="checkbox"/>	Kneese, Kyle C	Approved - IDMS data file att.
DOE – ORP Public Affairs/Communications	<input checked="" type="checkbox"/>	<input type="checkbox"/>	Dawson, Edward M	Approved - IDMS data file att.
Other: DOE SME	<input checked="" type="checkbox"/>	<input type="checkbox"/>	Nelson, Erik N	Approved - IDMS data file att.
Other:	<input type="checkbox"/>	<input type="checkbox"/>		

Comments Required for H2C-Indicate Purpose of Document:

This report is the official inventory for radioactive waste stored in underground tanks in the 200 Areas at the Hanford Site. Data that depict the status of stored radioactive waste and tank vessel integrity are contained within the report. This report provides data on each of the existing 177 large underground waste storage tanks and smaller miscellaneous underground storage tanks (MUST) and special surveillance facilities, and supplemental information regarding tank surveillance anomalies and ongoing investigations. This report is intended to meet the requirement of DOE O 435.1, Radioactive Waste Management, requiring the reporting of tank waste volumes and space utilization by contractors performing work that involves the management of DOE radioactive waste at DOE owned or leased facilities.

APPROVED

By Sarah Harrison at 10:01 am, Apr 22, 2025

Approved for Public Release;
Further Dissemination Unlimited

Information Release Station

Was/Is Information Product Approved for Release? Yes No

If Yes, what is the Level of Releaser? Public/Unrestricted Other (Specify) _____

Date Information Product Stamped/Marked for Release: 04/22/2025

Was/Is Information Product Transferred to OSTI? Yes No

Forward Copies of Completed Form to H2C Originator

HNF-EP-0182
Revision 447

Waste Tank Summary Report for Month Ending March 31, 2025

Prepared for the U.S. Department of Energy
Assistant Secretary for Environmental Management

Contractor for the U.S. Department of Energy
Hanford Field Office under Contract No. 89303324DEM000096



**P.O. Box 850
Richland, Washington**

**Approved for Public Release;
Further Dissemination Unlimited**

HNF-EP-0182
Revision 447

Waste Tank Summary Report for Month Ending March 31, 2025

Prepared by

M. J. Rodgers
Hanford Tank Waste Operations & Closure, LLC

Date Published
April 2025

Prepared for the U.S. Department of Energy
Assistant Secretary for Environmental Management

Contractor for the U.S. Department of Energy
Hanford Field Office under Contract No. 89303324DEM000096



P.O. Box 850
Richland, Washington

Approved for Public Release; Further Dissemination Unlimited

HNF-EP-0182
Revision 447

TRADEMARK DISCLAIMER

Reference herein to any specific commercial product, process, or service by trade name, trademark, manufacturer, or otherwise, does not necessarily constitute or imply its endorsement, recommendation, or favoring by the United States Government or any agency thereof or its contractors or subcontractors.

This report has been reproduced from the best available copy.
Available in paper copy.

HNF-EP-0182
Revision 447

RECORD OF REVISION

Date	Revision	Description	Changed by
1/24/2001	153	EDT-631372	B. M. Hanlon
Record of revision truncated for brevity			
05/01/2023	423	Complete revision	B. D. Hay
5/24/2023	424	Complete revision	M. J. Rodgers
6/29/2023	425	Complete revision	M. J. Rodgers
7/31/2023	426	Complete revision	M. J. Rodgers
8/30/2023	427	Complete revision	M. J. Rodgers
10/4/2023	428	Complete revision	M. J. Rodgers
10/30/2023	429	Complete revision	M. J. Rodgers
11/29/2023	430	Complete revision	M. J. Rodgers
12/21/2023	431	Complete revision	M. J. Rodgers
1/30/2024	432	Complete revision	M. J. Rodgers
2/29/2024	433	Complete revision	M. J. Rodgers
3/27/2024	434	Complete revision	M. J. Rodgers
4/30/2024	435	Complete revision	M. J. Rodgers
5/30/2024	436	Complete Revision	M. J. Rodgers
6/26/2024	437	Complete Revision	M. J. Rodgers
7/30/2024	438	Complete Revision	M. J. Rodgers
8/29/2024	439	Complete Revision	M. J. Rodgers
9/26/2024	440	Complete Revision	M. J. Rodgers
10/29/2024	441	Complete Revision	M. J. Rodgers
11/26/2024	442	Complete Revision	M. J. Rodgers
12/19/2024	443	Complete Revision	M. J. Rodgers
1/28/2025	444	Complete Revision	M. J. Rodgers
2/27/2025	445	Complete Revision	M. J. Rodgers
3/31/2025	446	Complete Revision	M. J. Rodgers
4/24/2025	447	Complete Revision	M. J. Rodgers

This page intentionally left blank.

CONTENTS

1.0	PURPOSE AND SCOPE.....	1
1.1	Description of Table 1-1 Changes from Last Report	2
2.0	TANK OPERATIONS HIGHLIGHTS.....	9
2.1	Tank Waste Retrieval Status Highlights	9
2.2	DFLAW Status highlights	10
3.0	DOUBLE-SHELL TANKS MONTHLY SUMMARY TABLES.....	11
4.0	SINGLE-SHELL TANKS MONTHLY SUMMARY TABLES.....	15
4.1	Leak/Release Volume Estimates	21
4.2	Water Intrusion in Single-Shell Tanks	25
5.0	MISCELLANEOUS UNDERGROUND STORAGE TANKS AND SPECIAL SURVEILLANCE FACILITIES	27
6.0	ENDNOTES AND REFERENCES.....	35
6.1	Report Endnotes	35
6.2	References	47
7.0	APPENDIX A – GLOSSARY	A-1

FIGURES

Figure 1-1.	Double-Shell Tank Configuration.....	3
Figure 1-2.	Single-Shell Tank Configuration	3
Figure 1-3.	200 East Area Tank Waste Contents	5
Figure 1-4.	200 West Area Tank Waste Contents	7

TABLES

Table 1-1.	Waste Tank Summary – March 31, 2025	2
Table 2-1.	Tank Retrieval Status	9
Table 2-2.	TSCR Summary Report	10
Table 3-1.	Inventory and Status by Tanks – Double-Shell Tanks (2 pages).....	11
Table 3-2.	Double-Shell Tank Space Allocation, Inventory and Waste Receipts	13
Table 4-1.	Inventory and Status by Tanks – Single-Shell Tanks (6 pages)	15
Table 4-2.	SST Leak/Release Volume Estimates (3 pages).....	21
Table 4-3.	Assumed Leakers Re-evaluated as Sound via the Leak Assessment Process	24
Table 4-4.	DST Leak Volume Estimates.....	24
Table 4-5.	Single-Shell Tanks with Confirmed Water Intrusion (2 pages).....	25
Table 4-6.	Single-Shell Tanks with Evidence of Recent Water Intrusion	26
Table 5-1.	200 East Area Miscellaneous Underground Storage Tanks and Special Surveillance Facilities (4 pages)	27
Table 5-2.	200 West Area Miscellaneous Underground Storage Tanks and Special Surveillance Facilities (3 pages)	31
Table 6-1.	Waste Tank Summary Report Endnotes (11 pages)	35

TERMS**Acronyms and Abbreviations**

BBI	best-basis inventory
CAM	continuous air monitor
DCRT	double-contained receiver tank
DE	level decrease evaluation
DIL	drainable interstitial liquid
DOE	U.S. Department of Energy
DNO	did not operate
DST	double-shell tank
Ecology	State of Washington, Department of Ecology
FLA	formal leak assessment
H2C	Hanford Tank Waste Operations & Closure
HEPA	high-efficiency particulate air
HVAC	heating, ventilation, and air conditioning
IE	level increase evaluation
LOW	liquid observation well
MUST	miscellaneous underground storage tank
ORP	U.S. Department of Energy, Office of River Protection
OSD	operating specifications document
PUREX	plutonium/uranium extraction
R	retrieval (tank in retrieval)
RC	retrieval complete
RCR	retrieval complete – in review
RECUPLEX	recovery of uranium and plutonium by extraction
REDOX	reduction-oxidation
SST	single-shell tank
TMACS	tank monitoring and control system
TSCR	Tank side cesium removal
TWINS	Tank Waste Information Network System
WAC	Washington Administrative Code
WI	water intrusion
WRPS	Washington River Protection Solutions LLC
WTP	Waste Treatment and Immobilization Plant
WVR	waste volume reduction

Units

ft	feet
gal	gallon
in.	inch
kgal	thousand gallons
Mgal	million gallons
min	minute
mo.	Month

This page intentionally left blank.

1.0 PURPOSE AND SCOPE

This report is the official inventory for radioactive waste stored in underground tanks in the 200 Areas at the Hanford Site. Data that depict the status of stored radioactive waste and tank vessel integrity are contained within the report. This report provides data on each of the existing 177 underground waste storage tanks and smaller miscellaneous underground storage tanks (MUST) and special surveillance facilities, and supplemental information regarding tank surveillance anomalies and ongoing investigations. This report is intended to meet the requirement of DOE O 435.1, *Radioactive Waste Management*, requiring the reporting of tank waste volumes and space utilization by contractors performing work that involves the management of DOE radioactive waste at DOE-owned or leased facilities.

Throughout this report, individual tanks and tank farms are referred to without the “241” preceding the tank/tank farm designator (e.g., Tank 241-C-102 is referred to as Tank C-102, and 241-A Tank Farm is referred to as A Farm).

1.1 DESCRIPTION OF TABLE 1-1 CHANGES FROM LAST REPORT

Table 1-1 summarizes the double-shell tank (DST) and single-shell tank (SST) information available in subsequent detailed tables and identifies changes in tank and waste status that have occurred during the report period. All table endnotes are included in Section 6.1.

Table 1-1. Waste Tank Summary – March 31, 2025

Total Waste Stored in DSTs and SSTs (millions of gallons)									
All DSTs & SSTs	1 year ago			1 month ago			Current		
	54.6			55.4			55.2		
Double-shell tanks	Sound DSTs			DSTs with Primary Tank Leak ⁽¹⁾			DSTs with Secondary Tank Leak		
	1 year ago	1 mo. ago	Current	1 year ago	1 mo. ago	Current	1 year ago	1 mo. ago	Current
	27	27	27	1	1	1	0	0	0
	DST Storage Capacity (Mgal)			Waste Stored in DSTs (Mgal)			Available DST Storage Space (Mgal)		
1 year ago	1 mo. ago	Current	1 year ago	1 mo. ago	Current	1 year ago	1 mo. ago	Current	
31.6	31.6	31.6	26.3	27.4	27.2	1.6	1.4	1.6	
Single-shell tanks	Sound SSTs			Non-Retrieved Assumed Leaker SSTs			Retrieved Assumed Leaker SSTs		
	1 year ago	1 mo. ago	Current	1 year ago	1 mo. ago	Current	1 year ago	1 mo. ago	Current
	93	92	92	50	51	51	6	6	6
	Total Waste Stored in SSTs (Mgal)			SSTs in Formal Leak Assessment			SSTs with Intrusions		
	1 year ago	1 mo. ago	Current	1 year ago	1 mo. ago	Current	1 year ago	1 mo. ago	Current
28.3	28.0	28.0	1	0	0	35	36	36	
SSTs in Retrieval ⁽⁴⁾			SST Retrieval Operations Complete ⁽⁵⁾						
1 year ago	1 mo. ago	Current	1 year ago	1 mo. ago	Current				
1	2	2	20	20	20				

DST = double-shell tank.

SST = single-shell tank.

Changes in the tank waste summaries listed in Table 1-1 from the previous revision of this report are summarized below.

- The evaporator campaign restarted this month, with approximately 218 kgal being transferred from the double-shell tanks to the 242-A Evaporator. This activity was the primary driver for reducing the waste in the DSTs from 27,391 kgal (27.4 Mgal) to 27,177 kgal (27.2 Mgal) and increasing the total available DST storage space to 1,617 kgal (1.6 Mgal). Total waste in the DSTs and SSTs is now 55,212 kgal (55.2 Mgal).

Illustrations of the DST and SST configurations are shown in Figure 1-1 and Figure 1-2, respectively. Figure 1-3 and Figure 1-4 summarize the 200 East Area and 200 West Area tank contents by tank farm.

Figure 1-1. Double-Shell Tank Configuration

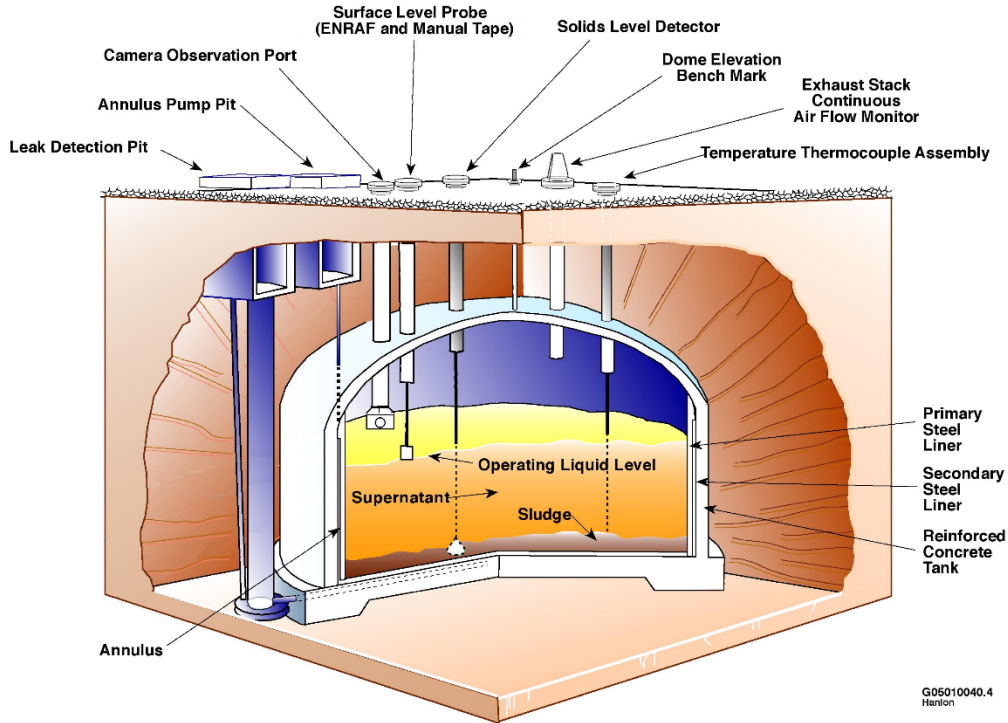
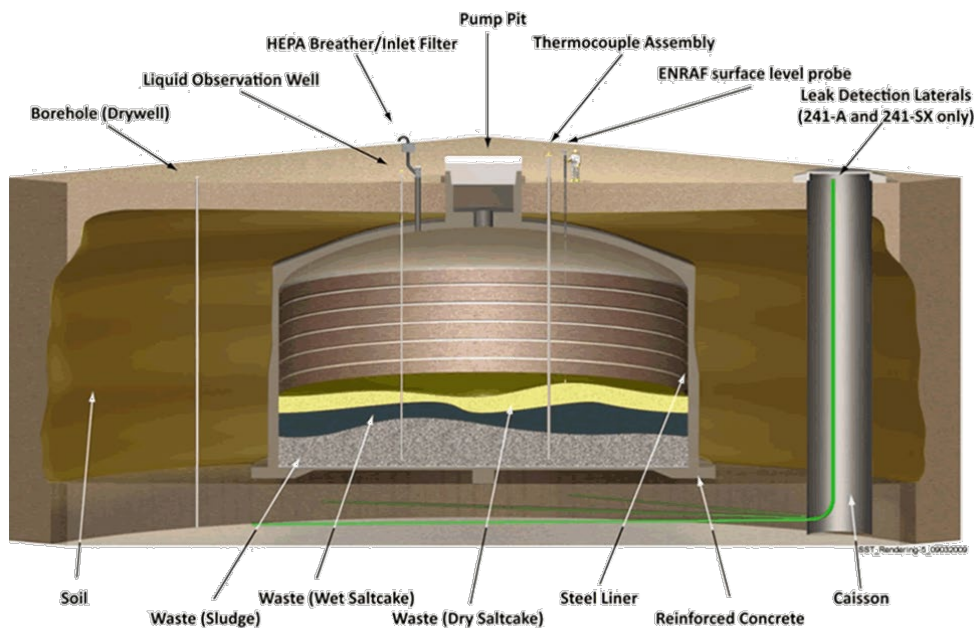

Figure 1-2. Single-Shell Tank Configuration



This page intentionally left blank.

Figure 1-3. 200-East Tank Waste Contents

A-Tank Farm- Constructed 1953-1955
6 @ 1,000 Kgal Tank Capacity, Single-Shell

Tank	Sludge	Saltcake	Supernatant
241-A-101	3	150	0
241-A-102	1	36	1
241-A-103	2	376	14
241-A-104	28	0	0
241-A-105	20	0	0
241-A-106	50	29	0

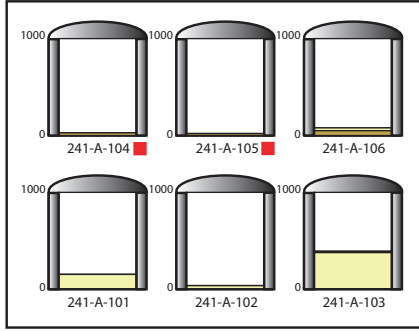

AZ-Tank Farm- Constructed 1970-1974
2 @ 1,018 Kgal Tank Capacity, Double-Shell

Tank	Sludge	Saltcake	Supernatant
241-AZ-101	53	0	919
241-AZ-102	100	0	850

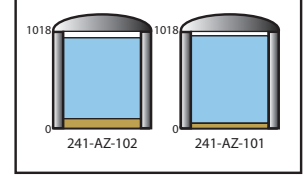

AN-Tank Farm- Constructed 1977-1980
7 @ 1,160 Kgal Tank Capacity, Double-Shell

Tank	Sludge	Saltcake	Supernatant
241-AN-101	635	30	412
241-AN-102	0	167	850
241-AN-103	0	510	452
241-AN-104	0	491	554
241-AN-105	0	536	584
241-AN-106	488	17	567
241-AN-107	0	240	802

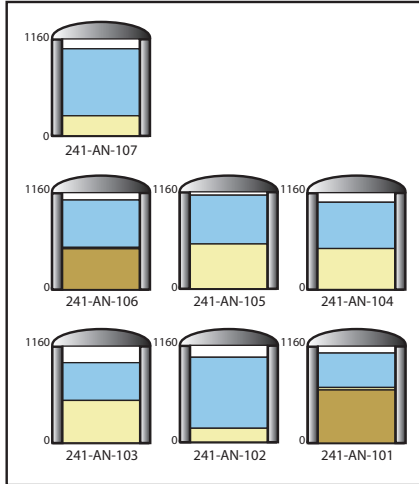

B-Tank Farm- Constructed 1943-1944
12 @ 530 Kgal Tank Capacity, Single-Shell

Tank	Sludge	Saltcake	Supernatant
241-B-101	33	75	0
241-B-102	0	30	1
241-B-103	1	36	2
241-B-104	309	54	5
241-B-105	28	260	0
241-B-106	109	0	4
241-B-107	83	72	1
241-B-108	25	59	1
241-B-109	50	80	0
241-B-110	237	0	7
241-B-111	216	0	1
241-B-112	14	17	4
241-B-201	28	0	2
241-B-202	27	0	2
241-B-203	49	0	1
241-B-204	48	0	2

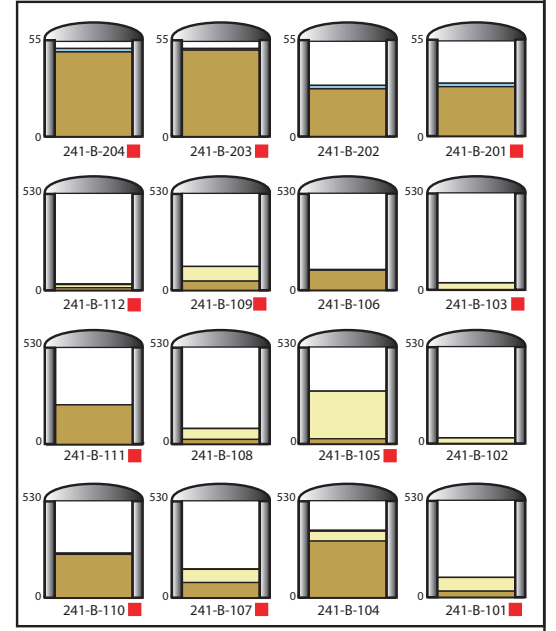

AP-Tank Farm- Constructed 1982-1986
1 @ 1,160 Kgal Tank Capacity, Double-Shell
7 @ 1,257 Kgal Tank Capacity, Double-Shell

Tank	Sludge	Saltcake	Supernatant
241-AP-101	0	33	1072
241-AP-102	165	0	939
241-AP-103	0	48	765
241-AP-104	0	88	572
241-AP-105	0	102	1141
241-AP-106	0	0	829
241-AP-107	0	60	1180
241-AP-108	0	111	1058

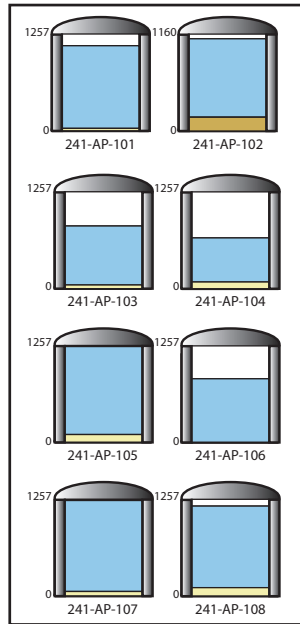

BX-Tank Farm- Constructed 1946-1947
12 @ 530 Kgal Tank Capacity, Single-Shell

Tank	Sludge	Saltcake	Supernatant
241-BX-101	43	0	12
241-BX-102	89	0	0
241-BX-103	62	0	13
241-BX-104	93	0	5
241-BX-105	42	22	4
241-BX-106	10	21	6
241-BX-107	337	0	6
241-BX-108	25	0	0
241-BX-109	185	0	4
241-BX-110	65	140	9
241-BX-111	30	83	3
241-BX-112	156	0	1

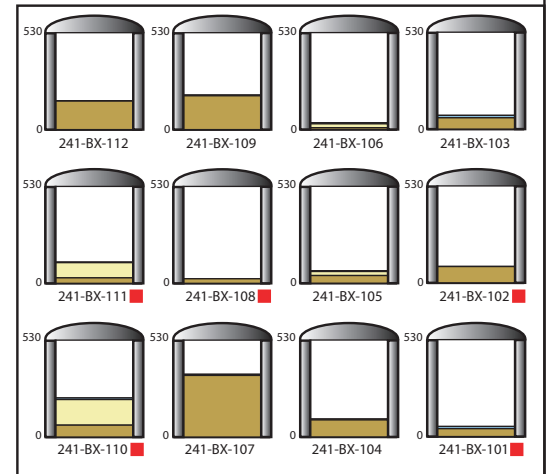

AW-Tank Farm- Constructed 1976-1980
6 @ 1,160 Kgal Tank Capacity, Double-Shell

Tank	Sludge	Saltcake	Supernatant
241-AW-101	0	405	732
241-AW-102	0	53	789
241-AW-103	280	40	739
241-AW-104	81	157	898
241-AW-105	248	0	847
241-AW-106	0	266	866

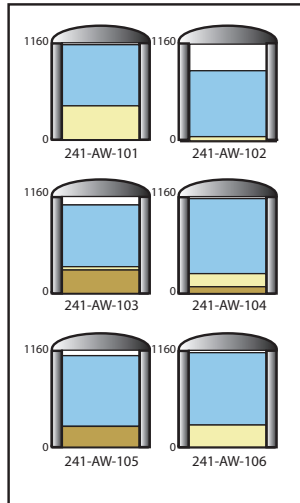

BY-Tank Farm- Constructed 1948-1949
12 @ 758 Kgal Tank Capacity, Single-Shell

Tank	Sludge	Saltcake	Supernatant
241-BY-101	37	329	0
241-BY-102	0	315	0
241-BY-103	9	398	1
241-BY-104	43	358	0
241-BY-105	48	429	0
241-BY-106	30	399	0
241-BY-107	16	270	0
241-BY-108	44	219	0
241-BY-109	23	273	0
241-BY-110	44	305	0
241-BY-111	0	398	0
241-BY-112	2	301	0

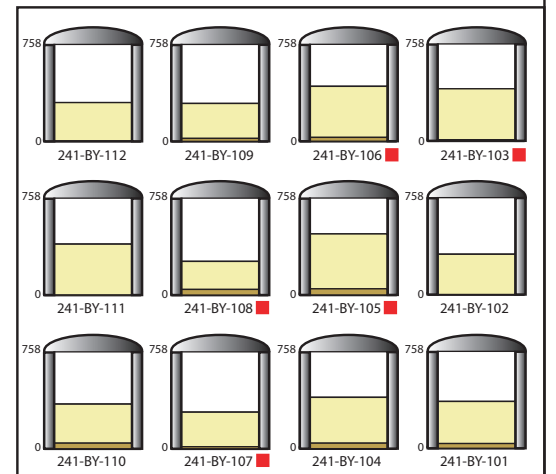

AX-Tank Farm- Constructed 1963-1965
4 @ 1,000 Kgal Tank Capacity, Single-Shell

Tank	Sludge	Saltcake	Supernatant
241-AX-101	2	5	0
241-AX-102	2.9	0	0
241-AX-103	6	0	0
241-AX-104	5.1	0	0

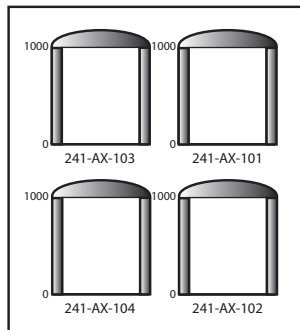

C-Tank Farm- Constructed 1943-1944
12 @ 530 Kgal Tank Capacity, Single-Shell
4 @ 55 Kgal Tank Capacity, Single-Shell

Tank	Sludge	Saltcake	Supernatant
241-C-101	5.5	0	0
241-C-102	15.5	0	0
241-C-103	2.3	0	0.2
241-C-104	1.9	0	0
241-C-105	1.5	0	0
241-C-106	2.4	0	0
241-C-107	10	0	0
241-C-108	3.4	0	0
241-C-109	2	0	0
241-C-110	2.1	0	0
241-C-111	4.9	0	0
241-C-112	10	0	0
241-C-201	0.1	0	0.2
241-C-202	0.1	0	0.2
241-C-203	0.1	0	0.2
241-C-204	0.1	0	0.1

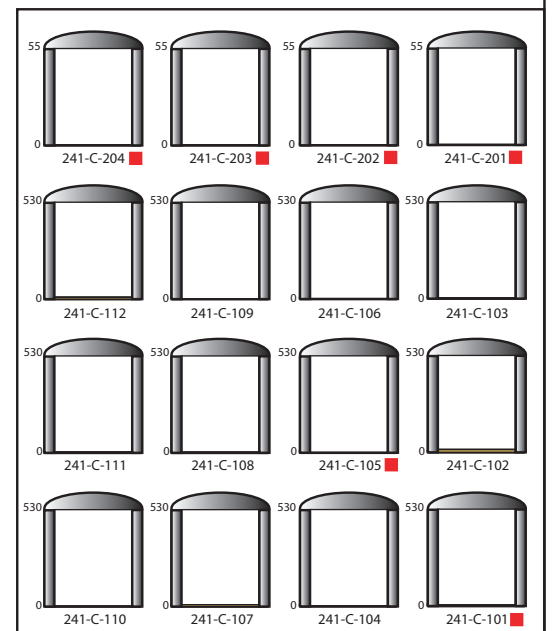

AY-Tank Farm- Constructed 1968-1970
2 @ 1,018 Kgal Tank Capacity, Double-Shell

Tank	Sludge	Saltcake	Supernatant
241-AY-101	95	0	902
241-AY-102	8	0	2

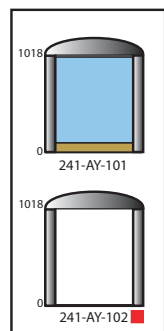
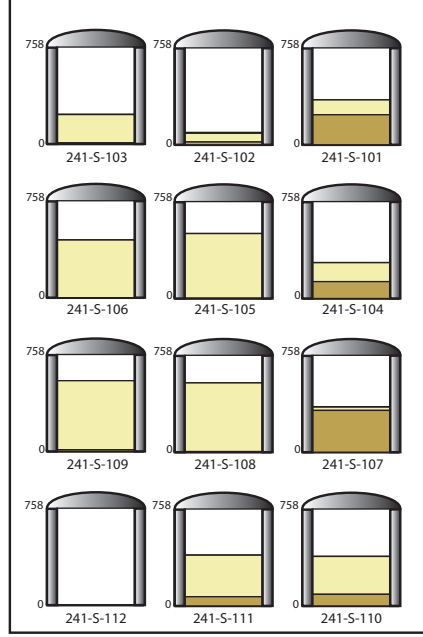

Figure 1-4. 200-West Tank Waste Contents

S-Tank Farm- Constructed 1950-1951
12 @ 758 Kgal Tank Capacity, Single-Shell

Tank	Sludge	Saltcake	Supernatant
241-S-101	235	116	0
241-S-102	22	68	6
241-S-103	9	221	1
241-S-104	132	148	1
241-S-105	2	506	0
241-S-106	0	451	0
241-S-107	327	26	2
241-S-108	5	537	0
241-S-109	13	540	0
241-S-110	91	296	0
241-S-111	72	325	0
241-S-112	2.5	0	0



TX-Tank Farm- Constructed 1947-1948
18 @ 758 Kgal Tank Capacity, Single-Shell

Tank	Sludge	Saltcake	Supernatant
241-TX-101	73	9	7
241-TX-102	2	231	0
241-TX-103	0	126	2
241-TX-104	33	30	3
241-TX-105	11	589	0
241-TX-106	5	386	0
241-TX-107	0	27	0
241-TX-108	6	110	1
241-TX-109	375	0	0
241-TX-110	37	424	0
241-TX-111	43	317	0
241-TX-112	0	627	0
241-TX-113	88	546	0
241-TX-114	4	510	0
241-TX-115	9	625	0
241-TX-116	66	497	0
241-TX-117	29	597	0
241-TX-118	0	250	0

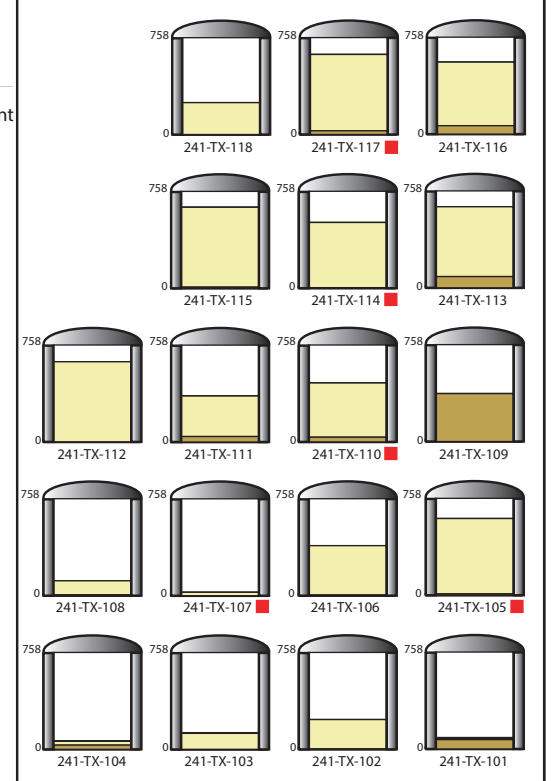

SX-Tank Farm- Constructed 1953-1955
15 @ 1,000 Kgal Tank Capacity, Single-Shell

Tank	Sludge	Saltcake	Supernatant
241-SX-101	141	275	0
241-SX-102	55	287	0
241-SX-103	80	519	0
241-SX-104	68	354	0
241-SX-105	65	311	0
241-SX-106	0	267	1
241-SX-107	130	0	0
241-SX-108	84	0	0
241-SX-109	66	206	0
241-SX-110	49	10	0
241-SX-111	97	20	0
241-SX-112	90	0	0
241-SX-113	19	0	0
241-SX-114	127	29	0
241-SX-115	4	0	0

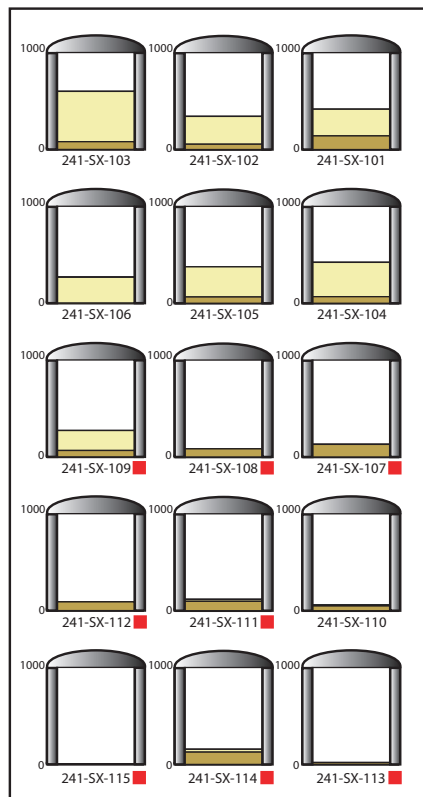

TY-Tank Farm- Constructed 1951-1952
6 @ 758 Kgal Tank Capacity, Single-Shell

Tank	Sludge	Saltcake	Supernatant
241-TY-101	59	47	0
241-TY-102	0	61	10
241-TY-103	108	40	0
241-TY-104	39	0	4
241-TY-105	187	0	0
241-TY-106	13	0	0

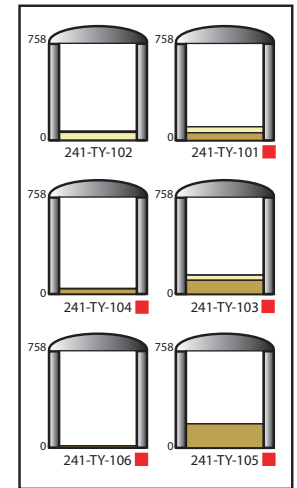

SY-Tank Farm- Constructed 1974-1976
3 @ 1,160 Kgal Tank Capacity, Double-Shell

Tank	Sludge	Saltcake	Supernatant
241-SY-101	0	223	880
241-SY-102	220	0	294
241-SY-103	0	410	322

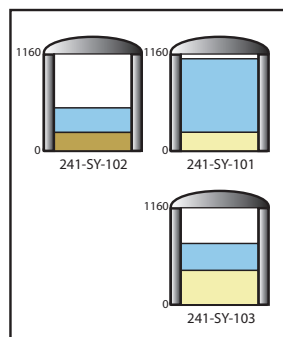

T-Tank Farm- Constructed 1943-1944
12 @ 530 Kgal Tank Capacity, Single-Shell
4 @ 55 Kgal Tank Capacity, Single-Shell

Tank	Sludge	Saltcake	Supernatant
241-T-101	37	49	7
241-T-102	19	0	11
241-T-103	22	0	4
241-T-104	309	0	0
241-T-105	89	0	1
241-T-106	21	0	0
241-T-107	160	0	7
241-T-108	8	8	0
241-T-109	0	98	1
241-T-110	351	0	2
241-T-111	399	0	0
241-T-112	55	0	7
241-T-201	28	0	4
241-T-202	20	0	0
241-T-203	35	0	0
241-T-204	37	0	0

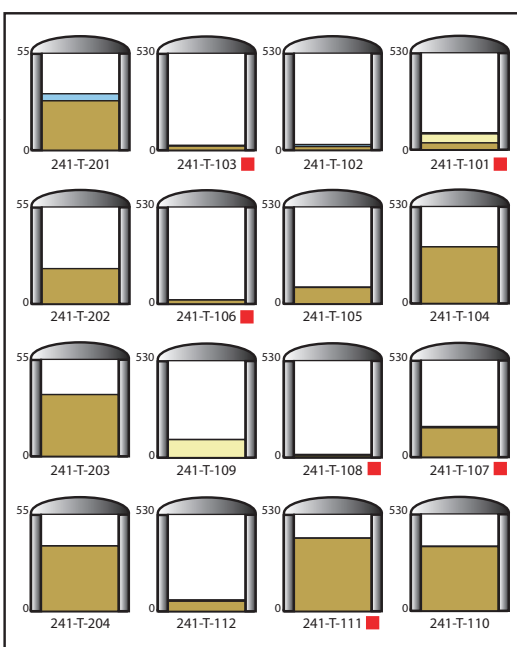

U-Tank Farm- Constructed 1943-1944
12 @ 530 Kgal Tank Capacity, Single-Shell
4 @ 55 Kgal Tank Capacity, Single-Shell

Tank	Sludge	Saltcake	Supernatant
241-U-101	21	0	9
241-U-102	43	296	4
241-U-103	13	396	3
241-U-104	45	39	0
241-U-105	32	311	2
241-U-106	0	163	2
241-U-107	16	259	0
241-U-108	29	399	0
241-U-109	32	357	1
241-U-110	186	0	0
241-U-111	26	200	0
241-U-112	44	0	4
241-U-201	4	0	1
241-U-202	5	0	0.3
241-U-203	2.4	0	1.1
241-U-204	2	0	1

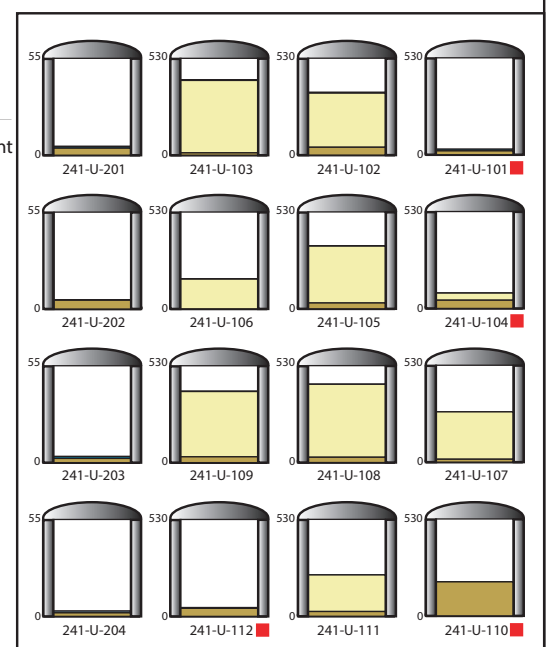

2.0 TANK OPERATIONS HIGHLIGHTS

2.1 TANK WASTE RETRIEVAL STATUS HIGHLIGHTS

The waste retrieval status of Hanford DSTs and SSTs is summarized in Table 2-1.

Table 2-1. Tank Retrieval Status

Tank (241-)	Status ⁽⁵⁾	Comments	Nominal Volume of Remaining Waste ⁽⁸⁾ (kgal)	Notes (see Section 6.1)
A-101	Ongoing	Retrieval in progress – retrieval initiated 7/19/2024	153.2	(124)
A-102	Ongoing	Retrieval in progress – retrieval initiated 1/30/2025	38.4	(127)
AX-101	Ongoing	Retrieval operations halted while evaluation to certify completion are underway – retrieval initiated 1/13/2023	10.7	(121)
AX-102	Complete	Declared “Retrieval Completed,” 9/13/2021	2.9	(5)(110)
AX-103	Complete	Declared “Retrieval Completed,” 1/17/2023	5.9	(5)(116)
AX-104	Complete	Declared “Retrieval Completed,” 9/29/2022	5.1	(5)(113)
AY-102	Complete	Declared “Retrieved to Limit of First and Second Retrieval Technologies,” 2/15/2017	10.0	(5)(90)
C-101	Complete	Declared “Retrieval Completed,” 9/24/2014	5.5	(5)(9)
C-102	Complete	Declared “Retrieval Completed,” 11/30/2015	15.5	(5)(10)
C-103	Complete	Declared “Retrieval Completed,” 8/23/2006	2.5	(5)(11)
C-104	Complete	Declared “Retrieval Completed,” 8/17/2012	1.9	(5)(12)
C-105	Complete	Declared “Retrieval Completed,” 6/28/2018	1.5	(5)(13)
C-106	Complete	Declared “Retrieval Completed,” 12/31/2003	2.4	(5)(14)
C-107	Complete	Declared “Retrieval Completed,” 9/30/2014	10.0	(5)(15)
C-108	Complete	Declared “Retrieval Completed,” 5/1/2013	3.4	(5)(16)
C-109	Complete	Declared “Retrieval Completed,” 6/4/2013	2.0	(5)(17)
C-110	Complete	Declared “Retrieval Completed,” 10/30/2013	2.1	(5)(18)
C-111	Complete	Declared “Retrieval Completed,” 8/29/2016	4.9	(5)(19)
C-112	Complete	Declared “Retrieval Completed,” 5/29/2014	10.0	(5)(20)
C-201	Complete	Declared “Retrieval Completed,” 3/23/2006	0.37	(5)(21)
C-202	Complete	Declared “Retrieval Completed,” 8/11/2005	0.35	(5)(22)
C-203	Complete	Declared “Retrieval Completed,” 3/24/2005	0.35	(5)(23)
C-204	Complete	Declared “Retrieval Completed,” 12/11/2006	0.14	(5)(24)
S-112	Complete	Declared “Retrieval Completed,” 3/2/2007	2.7	(5)(25)

2.2 DFLAW STATUS HIGHLIGHTS

TSCR did not operate during the month of March 2025.

The TSCR Low Activity Waste processing status is summarized below in Table 2-2.

Table 2-2. TSCR Summary Report

Campaign Summary	Campaign-01A
Campaign Start Date/Time	3/26/24 9:48 PM
Report Date/Time	11/30/24 3:36 AM
Total Campaign Feed Volume from AP-107 (gallons)	799,406
Feed in AP-107 at Start of Campaign (gallons)	983,235
Available Feed Remaining in AP-107 (gallons)	183,829
Waste Stored in AP-106 (gallons)	831,793
Percent Completed for this Campaign ^a	81%
Batch Summary (Total Prior to Column Changeout)	Batch4
Batch Start Date/Time	11/3/24 1:31 AM
Total Projected Batch Feed Volume from AP-107 (gallons) ^b	194,000
Total Actual Feed from AP-107 (gallons)	194,598
Estimated TSCR Batch Completed (percent)	100%

^a The TSCR campaign will likely be declared complete prior to processing all the available AP-107 feed so that IXC changeout can commence when operationally required (i.e., when the gamma monitors indicate the end of a batch).

^b This volume estimates total batch volume predicted from modeling data but will be limited by breakthrough. A batch is the volume fed from AP-107 and through the lead/lag/polish columns between column changeout cycles.

3.0 DOUBLE-SHELL TANKS MONTHLY SUMMARY TABLES

The DST waste inventory and tank status are summarized in Table 3-1. DST space allocation, inventory, and waste receipts are summarized in Table 3-2.

Table 3-1. Inventory and Status by Tanks – Double-Shell Tanks (2 pages)

All volume data obtained from Tank Waste Information Network System (TWINS)

Tank (241-)	Tank Integrity	Tank Level (in.)	Total Waste (kgal)	Available Space (kgal)	Waste volumes			Solids Volume Update
					Supernatant Liquid (kgal)	Sludge (kgal)	Saltcake (kgal)	
AN Farm Status								
AN-101	Sound	392	1077	83	412	635	30	7/1/2022
AN-102	Sound	370	1017	143	850	0	167	7/1/2023
AN-103	Sound	350	962	198	452	0	510	10/1/2016
AN-104	Sound	380	1045	115	554	0	491	10/1/2016
AN-105	Sound	407	1120	40	584	0	536	10/1/2016
AN-106	Sound	390	1072	88	567	488	17	10/1/2021
AN-107	Sound	379	1042	118	802	0	240	5/1/2023
7 tanks – Total			7,335	785	4,221	1,123	1,991	
AP Farm Status								
AP-101	Sound	402	1105	152	1072	0	33	2/1/2025
AP-102	Sound	402	1104	56	939	165	0	10/1/2023
AP-103	Sound	296	813	444	765	0	48	10/1/2024
AP-104	Sound	240	660	597	572	0	88	1/1/2025
AP-105	Sound	452	1243	14	1141	0	102	8/1/2024
AP-106	Sound	302	829	428	829	0	0	1/1/2025
AP-107	Sound	451	1240	17	1180	0	60	1/1/2025
AP-108	Sound	425	1169	88	1058	0	111	1/1/2025
8 tanks – Total			8,163	1,796	7,556	165	442	
AW Farm Status								
AW-101	Sound	414	1137	23	732	0	405	10/1/2016
AW-102	Sound	306	842	318	789	0	53	1/1/2025
AW-103	Sound	385	1059	101	739	280	40	1/1/2022
AW-104	Sound	413	1136	24	898	81	157	7/1/2024
AW-105	Sound	398	1095	65	847	248	0	11/1/2024
AW-106	Sound	412	1132	28	866	0	266	7/1/2018
6 tanks – Total			6,401	559	4,871	609	921	

HNF-EP-0182
Revision 447**Table 3-1. Inventory and Status by Tanks – Double-Shell Tanks (2 pages)**

All volume data obtained from Tank Waste Information Network System (TWINS)

Tank (241-)	Tank Integrity	Tank Level (in.)	Total Waste (kgal)	Available Space (kgal)	Waste volumes			Solids Volume Update
					Supernatant Liquid (kgal)	Sludge (kgal)	Saltcake (kgal)	
AY Farm Status								
AY-101	Sound	363	997	21	902	95	0	4/1/2024
AY-102	Assumed leaker; primary tank	N/A ^a	10 ^a	0 ^a	2	8	0	1/1/2023
2 tanks – Total			1007	21	904	103	0	
AZ Farm Status								
AZ-101	Sound	354	972	46	919	53	0	7/13/2023
AZ-102	Sound	346	950	68	850	100	0	7/1/2024
2 tanks – Total			1,922	114	1,769	153	0	
SY Farm Status								
SY-101	Sound	401	1103	57	880	0	223	7/1/2024
SY-102	Sound	187	514	646	294	220	0	12/1/2024
SY-103	Sound	266	732	428	322	0	410	1/1/2024
3 tanks – Total			2,349	1,131	1,496	220	633	

Notes:

1 kgal differences are the result of computer rounding.

Supernatant + sludge (includes liquid) + saltcake (includes liquid) = total waste.

Available space volumes include restricted space.

Tanks AN-103, AN-104, AN-105, AW-101, SY-101, and SY-103 contain retained gas in the saltcake.

The Solids Volume Update is the date of the most recent BBI estimate or for tanks undergoing retrieval, it is the date of the most recent engineering volume estimate.

^a AY-102 available space updated to reflect AY-102 status as an assumed leaker. The tank level is Not Applicable (N/A), the Enraf® is out of service, the surface of the waste is not uniform and therefore the Enraf® is not providing accurate measurements. The Total Waste for AY-102 in this table does not include the waste in the annulus.

Table 3-2. Double-Shell Tank Space Allocation, Inventory and Waste Receipts

Total DST Capacity (kgal)	Total DST Waste Inventory (kgal)		Allocation of Remaining DST Space (kgal)	
31,583	Inventory on 03/31/2025 =	27,177	Total DST capacity ^{a,b} =	31,583
	Inventory on 02/28/2025 =	27,391	Waste inventory =	-27,177
	Change =	-214	Restricted usage space ^c =	-1,524
			Emergency space allocation ^d =	-1,265
			Available space =	1,617

^a Assumes maximum authorized limits per OSD-T-151-00007, *Operating Specifications for the Double-Shell Storage Tanks*: AN, AW, SY Farm = 422 in., AP Farm = 458 in., except Tank AP-102 = 422 in.; AY and AZ Farms = 370 in. Volumes at maximum authorized limit from RPP-CALC-33163, *Tank Waste Volume and Level Calculations in Dome Space for 241-AP Tank Farm Up to 460 Inches*, and RPP-13019, *Determination of Hanford Waste Tank Volumes*.

^b Total DST capacity was changed to reflect Tank AY-102 as an assumed leaker.

^c Restricted space associated with flammable gas Waste Group A (RPP-10006, *Methodology and Calculations for the Assignment of Waste Groups for the Large Underground Waste Storage Tanks at the Hanford Site*) and tanks controlled for waste feed delivery per feed control list (HNF-SD-WM-OCD-015, *Tank Farms Waste Transfer Compatibility Program*). These tanks are Tanks AN-102, AN-103, AN-104, AN-105, AN-107, AP-105, AP-106, AP-107, AW-101, AY-102, and SY-103.

^d Includes 1,265 kgal emergency space allocation (HNF-SD-WM-OCD-015).

Facility Generations (kgal)		Gains Associated With (kgal)		Reductions Associated With (kgal)	
Tank farms	1	AZ-301 condensate	0	Transfers to 242-A facility	218
242-A Evaporator ⁱ	11	Instrumentation ^e	0	Instrumentation ^e	0
Nitrite/Caustic	0	Miscellaneous ^f	0	Miscellaneous ^f	0
A-101 Retrieval	0	Thermal expansion ^h	1	Waste evaporation	9
TSCR Operations ^j	0				
Total =	12	Total =	1	Total =	227

DST Net Waste Inventory Change					
Date	Facility Generation (kgal)	Gains (kgal)	Reductions (kgal)	Net waste Volume Change (kgal)	Total DST Waste Inventory (kgal)
03/2025	12	1	227	-214	27,177

^e Adjustments due to instrumentation including recalibrations and/or instrument flushing.

^f Adjustments for gas retention and release from Waste Group A tanks.

^g A negative value for a retrieval number indicates the net total of retrieval and pumping of supernatant liquid back into the SST for soak of hard-heel solids.

^h Adjustments for thermal expansion of liquids inside tanks.

ⁱ Evaporator gains include additions of pump seal water, slurry, and condensate.

^j TSCR Operations include the net total of waste feed streams out of and treated waste back into the DSTs.

DST = double-shell tank.

SST = single-shell tank.

WTP = Waste Treatment and Immobilization Plant.

WVR = waste volume reduction.

This page intentionally left blank.

4.0 SINGLE-SHELL TANKS MONTHLY SUMMARY TABLES

The SST waste inventory and tank status are summarized in Table 4-1.

Table 4-1. Inventory and Status by Tanks – Single-Shell Tanks (6 pages)

All volume data obtained from Tank Waste Information Network System (TWINS)

Tank (241-)	Tank Integrity	Table 1-1 Tank Status	Total Waste (kgal) ^a	Drainable Interstitial Liquid (kgal) ⁽¹⁰⁸⁾	Waste Volumes ⁽²⁶⁾			Solids Volume Update ⁽⁸⁹⁾
					Supernatant Liquid (kgal)	Sludge (kgal)	Saltcake (kgal)	
A Farm Status								
A-101 ⁽²⁷⁾	Sound	R	153 ⁽¹²⁴⁾		Retrieval in Progress			1/1/2025
A-102	Sound	R, WI	38 ⁽¹²⁷⁾		Retrieval in Progress			2/1/2025
A-103 ⁽²⁸⁾	Sound		392	87	14	2	376	10/1/2020
A-104	Assumed leaker		28	0	0	28	0	7/1/2022
A-105	Assumed leaker		20	0	0	20	0	4/1/2020
A-106	Sound		79	0	0	50	29	9/1/2024
6 tanks – Total			710		15	104	591	
AX Farm Status								
AX-101	Sound	R	8 ^a		Retrieval in Progress			1/1/2025
AX-102	Sound	RC	2.9		Retrieval completed 9/13/2021 ⁽⁵⁾			9/1/2021
AX-103	Sound	RC	6		Retrieval completed 1/17/2023 ⁽⁵⁾			4/1/2023
AX-104	Sound	RC	5.1		Retrieval Completed 9/29/2022 ⁽⁵⁾			4/1/2022
4 tanks – Total			22.0		0	16	5	
B Farm Status								
B-101	Assumed leaker		108	18	0	33	75	10/1/2024
B-102	Sound		31	5.7	1	0	30	4/1/2022
B-103	Assumed leaker	WI	39	8.3	2	1	36	1/1/2023
B-104	Sound		369 ^a	58	5	309	54	1/1/2025
B-105	Assumed leaker		288	18	0	28	260	7/1/2023
B-106	Sound		113	12	4	109	0	10/1/2021
B-107	Assumed leaker		156	20	1	83	72	1/1/2025
B-108	Sound		86 ^a	15	1	25	59	1/1/2022
B-109	Assumed leaker		130	13	0	50	80	9/1/2021
B-110	Assumed leaker		244	33	7	237	0	2/1/2020
B-111	Assumed leaker		217	29	1	216	0	7/1/2024
B-112	Assumed leaker	WI	35	4.2	4	14	17	2/1/2022
B-201	Assumed leaker	WI	30	4.2	2	28	0	1/1/2025
B-202	Sound	WI	29	4.1	2	27	0	10/1/2024
B-203	Assumed leaker		50	7.7	1	49	0	10/1/2024
B-204	Assumed leaker		50	7.6	2	48	0	10/1/2024
16 tanks – Total			1,975		33	1,257	683	

HNF-EP-0182
Revision 447**Table 4-1. Inventory and Status by Tanks – Single-Shell Tanks (6 pages)**

All volume data obtained from Tank Waste Information Network System (TWINS)

Tank (241-)	Tank Integrity	Table 1-1 Tank Status	Total Waste (kgal) ^a	Drainable Interstitial Liquid (kgal) ⁽¹⁰⁸⁾	Waste Volumes ⁽²⁶⁾			Solids Volume Update ⁽⁸⁹⁾
					Supernatant Liquid (kgal)	Sludge (kgal)	Saltcake (kgal)	
BX Farm Status								
BX-101	Assumed leaker	WI	55	0.3	12	43	0	4/1/2024
BX-102	Assumed leaker		89	0	0	89	0	8/1/2019
BX-103	Sound	WI	75	3.4	13	62	0	1/1/2023
BX-104	Sound	WI	98	8.6	5	93	0	7/1/2024
BX-105	Sound		68	6.0	4	42	22	7/1/2021
BX-106	Sound		37	6.4	6	10	21	7/1/2020
BX-107	Sound	WI	343	39	6	337	0	7/1/2020
BX-108	Assumed leaker		25	0	0	25	0	11/1/2022
BX-109	Sound		189	29	4	185	0	10/1/2020
BX-110	Assumed leaker	WI	214	36	9	65	140	3/1/2023
BX-111	Assumed leaker		116	16	3	30	83	4/1/2024
BX-112	Sound		157	10	1	156	0	11/1/2020
12 tanks – Total			1,466		63	1,137	266	
BY Farm Status								
BY-101	Sound		366	37	0	37	329	4/1/2024
BY-102	Sound	WI	315	44	0	0	315	4/1/2024
BY-103	Assumed leaker	WI	408	66	1	9	398	1/1/2022
BY-104	Sound		401	42	0	43	358	4/1/2022
BY-105	Assumed leaker		477	51	0	48	429	7/1/2020
BY-106	Assumed leaker		429	54	0	30	399	8/1/2016
BY-107	Assumed leaker		286	37	0	16	270	4/1/2022
BY-108	Assumed leaker		264 ^a	27	0	44	219	1/1/2022
BY-109	Sound	WI	296	83	0	23	273	2/1/2022
BY-110	Sound		349	27	0	44	305	7/1/2024
BY-111	Sound		398	41	0	0	398	1/1/2024
BY-112	Sound		303	21	0	2	301	7/1/2022
12 Tanks – Total			4,292		1	296	3,994	

HNF-EP-0182
Revision 447**Table 4-1. Inventory and Status by Tanks – Single-Shell Tanks (6 pages)**

All volume data obtained from Tank Waste Information Network System (TWINS)

Tank (241-)	Tank Integrity	Table 1-1 Tank Status	Total Waste (kgal) ^a	Drainable Interstitial Liquid (kgal) ⁽¹⁰⁸⁾	Waste Volumes ⁽²⁶⁾			Solids Volume Update ⁽⁸⁹⁾
					Supernatant Liquid (kgal)	Sludge (kgal)	Saltcake (kgal)	
C Farm Status								
C-101	Assumed leaker	RC	5.5	Retrieved to limit of first and second retrieval technologies 9/25/2013 ⁽⁹⁾				10/1/2023
C-102	Sound	RC	15.5	Retrieval completed 11/30/2015 ⁽¹⁰⁾				1/1/2023
C-103	Sound	RC	2.5	Retrieval completed 8/23/2006 ⁽¹¹⁾				1/1/2023
C-104	Sound	RC	1.9	Retrieval completed 8/17/2012 ⁽¹²⁾				7/1/2023
C-105 ⁽²⁹⁾	Assumed leaker	RC	1.5	Retrieval Completed 6/28/2018 ⁽¹³⁾				7/1/2023
C-106	Sound	RC	2.4	Retrieval completed 12/31/2003 ⁽¹⁴⁾				10/1/2023
C-107	Sound	RC	10.0	Retrieved to limit of third retrieval technology 9/30/14 ⁽¹⁵⁾				7/1/2023
C-108	Sound	RC	3.4	Retrieved to limit of modified sluicing technology 3/22/2012 ⁽¹⁶⁾				7/1/2023
C-109	Sound	RC	2.0	Retrieved to limit of modified sluicing technology 9/12/2012 ⁽¹⁷⁾				7/1/2023
C-110 ⁽³⁰⁾	Sound	RC	2.1	Retrieval completed 10/30/13 ⁽¹⁸⁾				10/1/2024
C-111 ⁽³¹⁾	Sound	RC	4.9	Retrieval completed 8/29/2016 ⁽¹⁹⁾				10/1/2023
C-112	Sound	RC	10.0	Retrieval completed 5/29/2014 ⁽²⁰⁾				10/1/2023
C-201	Assumed leaker	WI/RC	0.37	Retrieval completed 3/23/2006 ⁽²¹⁾				5/1/2022
C-202	Assumed leaker	WI/RC	0.35	Retrieval completed 8/11/2005 ⁽²²⁾				5/1/2022
C-203	Assumed leaker	WI/RC	0.35	Retrieval completed 3/24/2005 ⁽²³⁾				5/1/2022
C-204	Assumed leaker	WI/RC	0.22	Retrieval completed 12/11/2006 ⁽²⁴⁾				9/1/2022
16 tanks – Total			62.99		0.9	61.9	0	
S Farm Status								
S-101	Sound		351	53	0	235	116	7/1/2022
S-102 ⁽²⁷⁾⁽³²⁾	Sound	WI	96	9.1	6	22	68	5/1/2022
S-103 ⁽³³⁾	Sound		231	52	1	9	221	7/1/2023
S-104	Sound		281	51	1	132	148	1/1/2024
S-105 ⁽³³⁾	Sound		508	44	0	2	506	7/1/2023
S-106 ⁽³³⁾	Sound	WI	451	47	0	0	451	7/1/2023
S-107	Sound	WI	354 ^a	46	2	327	26	4/1/2023
S-108	Sound		542	30	0	5	537	4/1/2021
S-109	Sound		553	27	0	13	540	10/1/2024
S-110	Sound		387	38	0	91	296	7/1/2023
S-111 ⁽²⁷⁾	Sound		397	54	0	72	325	2/1/2024
S-112	Sound	RC	2.5	Retrieval completed 3/2/2007 ⁽²⁵⁾				10/1/2021
12 tanks – Total			4,153.5		10	910.5	3,234	

HNF-EP-0182
Revision 447**Table 4-1. Inventory and Status by Tanks – Single-Shell Tanks (6 pages)**

All volume data obtained from Tank Waste Information Network System (TWINS)

Tank (241-)	Tank Integrity	Table 1-1 Tank Status	Total Waste (kgal) ^a	Drainable Interstitial Liquid (kgal) ⁽¹⁰⁸⁾	Waste Volumes ⁽²⁶⁾			Solids Volume Update ⁽⁸⁹⁾
					Supernatant Liquid (kgal)	Sludge (kgal)	Saltcake (kgal)	
SX Farm Status								
SX-101	Sound	WI	416	35	0	141	275	4/1/2021
SX-102	Sound	WI	342	30	0	55	287	1/1/2021
SX-103	Sound		599	42	0	80	519	1/1/2024
SX-104 ⁽³⁴⁾	Sound		422 ^a	31	0	68	354	1/1/2024
SX-105	Sound		376	41	0	65	311	7/1/2023
SX-106	Sound	WI	268	69	1	0	267	1/1/2020
SX-107	Assumed leaker		130	8.8	0	130	0	7/1/2022
SX-108	Assumed leaker		85 ^a	0	0	84	0	1/1/2025
SX-109	Assumed leaker		273 ^a	0	0	66	206	1/1/2024
SX-110 ⁽³⁵⁾	Sound		58 ^a	2.8	0	49	10	10/1/2023
SX-111	Assumed leaker		117	0	0	97	20	10/1/2023
SX-112	Assumed leaker	WI	90	0	0	90	0	4/1/2024
SX-113	Assumed leaker		19	0	0	19	0	10/1/2023
SX-114	Assumed leaker		155 ^a	21	0	127	29	10/1/2023
SX-115	Assumed leaker		4	0	0	4	0	1/1/2024
15 tanks – Total			3,354		1	1,075	2,278	
T Farm Status								
T-101 ⁽¹²⁵⁾	Assumed leaker	WI	93	11	7	37	49	1/1/2025
T-102	Sound		30	0	11	19	0	4/1/2021
T-103	Assumed leaker		27	0	4	22	0	10/1/2024
T-104	Sound		309	39	0	309	0	10/1/2024
T-105	Sound		89 ^a	7.9	1	89	0	1/1/2025
T-106	Assumed leaker		21	0	0	21	0	10/1/2024
T-107	Assumed leaker	WI	167	25	7	160	0	1/1/2019
T-108	Assumed leaker		16	2.0	0	8	8	4/1/2024
T-109	Sound		99	8.9	1	0	98	8/1/2020
T-110	Sound		353	56	2	351	0	10/1/2019
T-111	Assumed leaker	WI	400 ^a	37	0	399	0	4/1/2024
T-112	Sound		63 ^a	2.0	7	55	0	1/1/2025
T-201	Sound	WI	32	4.4	4	28	0	1/1/2025
T-202	Sound		20	2.6	0	20	0	1/1/2025
T-203	Sound		35	5.4	0	35	0	1/1/2025
T-204	Sound		37	5.6	0	37	0	1/1/2025
16 tanks – Total			1,791		44	1,590	155	

HNF-EP-0182
Revision 447**Table 4-1. Inventory and Status by Tanks – Single-Shell Tanks (6 pages)**

All volume data obtained from Tank Waste Information Network System (TWINS)

Tank (241-)	Tank Integrity	Table 1-1 Tank Status	Total Waste (kgal) ^a	Drainable Interstitial Liquid (kgal) ⁽¹⁰⁸⁾	Waste Volumes ⁽²⁶⁾			Solids Volume Update ⁽⁸⁹⁾
					Supernatant Liquid (kgal)	Sludge (kgal)	Saltcake (kgal)	
TX Farm Status								
TX-101	Sound	WI	90 ^a	8.6	7	73	9	1/1/2025
TX-102	Sound		233	49	0	2	231	1/1/2024
TX-103	Sound		128	25	2	0	126	4/1/2020
TX-104	Sound		66	8.2	3	33	30	10/1/2021
TX-105	Assumed leaker		600	46	0	11	589	2/1/2023
TX-106	Sound		391	57	0	5	386	4/1/2023
TX-107	Assumed leaker		27	5.8	0	0	27	1/1/2023
TX-108	Sound		117	26	1	6	110	11/1/2020
TX-109	Sound		375	48	0	375	0	8/1/2019
TX-110	Assumed leaker		461	32	0	37	424	4/1/2023
TX-111	Sound		360	25	0	43	317	7/1/2020
TX-112	Sound		627	61	0	0	627	8/8/2017
TX-113	Sound		634	25	0	88	546	8/1/2022
TX-114	Assumed leaker		514	42	0	4	510	10/1/2020
TX-115	Sound		634	84	0	9	625	1/1/2023
TX-116	Sound		562 ^a	27	0	66	497	4/1/2023
TX-117	Assumed leaker		626	16	0	29	597	1/1/2018
TX-118	Sound		250	70	0	0	250	7/1/2019
18 tanks – Total			6,695		13	781	5,901	
TY Farm Status								
TY-101	Assumed leaker		106	3.3	0	59	47	1/1/2023
TY-102	Sound	WI	70 ^a	14	10	0	61	4/1/2024
TY-103	Assumed leaker		148	21	0	108	40	2/1/2021
TY-104	Assumed leaker	WI	43	0	4	39	0	1/1/2022
TY-105	Assumed leaker		187	7.3	0	187	0	11/1/2018
TY-106	Assumed leaker		13	0	0	13	0	1/1/2017
6 tanks – Totals			567		14	406	148	

HNF-EP-0182
Revision 447**Table 4-1. Inventory and Status by Tanks – Single-Shell Tanks (6 pages)**

All volume data obtained from Tank Waste Information Network System (TWINS)

Tank (241-)	Tank Integrity	Table 1-1 Tank Status	Total Waste (kgal) ^a	Drainable Interstitial Liquid (kgal) ⁽¹⁰⁸⁾	Waste Volumes ⁽²⁶⁾			Solids Volume Update ⁽⁸⁹⁾
					Supernatant Liquid (kgal)	Sludge (kgal)	Saltcake (kgal)	
241-U Tank Farm Status								
U-101	Assumed leaker	WI	30	0	9	21	0	5/1/2021
U-102	Sound	WI	343	40	4	43	296	1/1/2023
U-103 ⁽²⁷⁾	Sound		412	31	3	13	396	10/1/2022
U-104	Assumed leaker		84	8.8	0	45	39	10/1/2022
U-105	Sound	WI	345	49	2	32	311	8/1/2022
U-106	Sound		165	40	2	0	163	1/1/2023
U-107	Sound		275	56	0	16	259	10/1/2022
U-108	Sound		428	68	0	29	399	10/1/2022
U-109 ⁽²⁷⁾	Sound	WI	390	76	1	32	357	11/1/2022
U-110	Assumed leaker		186	2.7	0	186	0	8/1/2022
U-111	Sound	WI	226	39	0	26	200	10/1/2022
U-112	Assumed leaker		48	0.2	4	44	0	12/1/2021
U-201	Sound		5	0.2	1	4	0	10/1/2022
U-202	Sound		5.3	0.1	0.3	5	0	10/1/2022
U-203	Sound		3.5	0	1.1	2.4	0	10/1/2022
U-204	Sound		3	0	1	2	0	10/1/2022
16 tanks – Totals			2,949		28	500	2,420	

^a 1 kgal differences are the result of computer rounding (e.g., volumes reported as 0 may represent as much as 499 gal of waste).

FLA = formal leak assessment
DE = level decrease evaluation.
IE = level increase evaluation.

R = retrieval (tank in retrieval)
RC = retrieval complete
RCR = retrieval complete – in review
WI = water intrusion
WI/RC = water intrusion/ retrieval complete

4.1 LEAK/RELEASE VOLUME ESTIMATES

RPP-32681, *Process to Assess Tank Farm Leaks in Support of Retrieval and Closure Planning*, established a revised process to estimate tank leak inventories. The process included assessing the source of tank farms leaks to support tank waste retrieval technology selections, and reassessing and updating volume estimates and inventories for previously identified tank leaks and releases. If the results suggest a change to the tank’s integrity classification, an integrity assessment was recommended per TFC-ENG-CHEM-P-57, “Tank Leak and Intrusion Assessment and Response.”

Table 4-2 shows release estimates from RPP-32681 assessments for SSTs currently classified as assumed leakers. Assessment results are summarized in RPP-RPT-61279, *Single-Shell Tank Farm Leak Inventory Assessments Summary*. As shown in endnotes to Table 4-2 provided in Section 6.1, a review of the current integrity classification was recommended for many of these tanks because release estimates for these tanks may be attributed to sources other than a tank liner leak (e.g., a spare inlet overflow, cascade line, transfer line, operations spill, etc.). Tanks previously classified as “assumed leakers” but re-evaluated as sound are listed in Table 4-3. Full reference citations are included in Section 6.2. Table 4-4 provides the DST primary tank leak volume estimate.

Table 4-2. SST Leak/Release Volume Estimates (3 pages)

Tank (241-)	Assumed Leaker ⁽⁴⁵⁾	Estimated Leak Volume (gal)	Interim Stabilized ⁽⁵¹⁾	Leak Estimate Updated	Notes (see Section 6.1)
A-104	1975	~2,000	9/1978	2017	(57)(85)
A-105	1963	2,000 to 40,000 plus 0-232,000 cooling water	7/1979	2017	(57)
B-101	1974 r ^a	~2,000	3/1981	2011	(48)(85)(99)
B-103	1978 r ^a	Not determined. Assumed 0	2/1985	2011	(48)(85)(99)
B-105	1978 r ^a	111,000	12/1984	2011	(48)(85)(99)
B-107	1980 r ^a	22,000	3/1985	2011	(85)(99)
B-109	2021	3,900	4/1985	2022	(115)(119)
B-110	1981 r ^a	13,000	3/1985	2011	(85)(99)
B-111	1978 r ^a	Not determined. Assumed 0	6/1985	2011	(48)(85)(99)
B-112	1978 r ^a	Not determined. Assumed 0	5/1985	2011	(48)(85)(99)
B-201	1980 r ^a	Not determined. Assumed 0	8/1981	2011	(85)(99)

HNF-EP-0182
Revision 447**Table 4-2. SST Leak/Release Volume Estimates (3 pages)**

Tank (241-)	Assumed Leaker ⁽⁴⁵⁾	Estimated Leak Volume (gal)	Interim Stabilized ⁽⁵¹⁾	Leak Estimate Updated	Notes (see Section 6.1)
B-203	1983 r ^a	Not determined. Assumed 0	6/1984	2011	(85)(99)
B-204	1984 r ^a	Not determined. Assumed 0	6/1984	2011	(85)(99)
BX-101	1972 r ^a	<900	9/1978	2011	(48)(85)(100)
BX-102	1971 r ^a	<140,000	11/1978	2011	(85)(100)
BX-108	1974 r ^a	Not determined. Assumed 2,000	7/1979	2011	(85)(100)
BX-110	1976 r ^a	Not determined. Assumed 8,000	8/1985	2011	(48)(85)(100)
BX-111	1984 r ^a	Not determined. Assumed 2,000	3/1995	2011	(48)(85)(100)
BY-103	1973 r ^a	<5,000	11/1997	2011	(85)(101)
BY-105	1984 r ^a	Not determined. Assumed 2,000	3/2003	2011	(48)(85)(101)
BY-106	1984 r ^a	Not determined. Assumed 2,000	N/A	2011	(48)(85)(101)
BY-107	1984 r ^a	Assumed 23,000	7/1979	2011	(85)(101)
BY-108	1972 r ^a	Not determined. Assumed 5,000	2/1985	2011	(85)(101)
C-101	1980	<37,000	11/1983	2016	(85)(102)
C-105	2010	2,000 to 20,500	10/1995	2016	(29)(102)
C-201	1988 r ^a	0	3/1982	2016	(85)(102)
C-202	1988 r ^a	0	8/1981	2016	(85)(102)
C-203	1984 r ^a	0	3/1982	2016	(102)
C-204	1988 r ^a	0	9/1982	2016	(85)(102)
SX-107	1964	6,000	10/1979	2010	(58)(85)
SX-108	1962	11,000 plus 39,000 to 90,000 water losses	8/1979	2010	(58)(85)
SX-109	1965	1,000	5/1981	2010	(58)(85)
SX-111	1974	2,800	7/1979	2010	(58)(85)
SX-112	1969	27,000	7/1979	2010	(58)(85)
SX-113	1962	15,000	11/1978	2010	(58)(85)
SX-114	1972	<2,000	7/1979	2010	(48)(58)(85)

HNF-EP-0182
Revision 447

Table 4-2. SST Leak/Release Volume Estimates (3 pages)

Tank (241-)	Assumed Leaker ⁽⁴⁵⁾	Estimated Leak Volume (gal)	Interim Stabilized ⁽⁵¹⁾	Leak Estimate Updated	Notes (see Section 6.1)
SX-115	1965	51,000	9/1978	2010	(58)(85)
T-101	2024	2,410	4/1993	2024	(85)(125)
T-103	1974 r ^a	1,300	11/1983	2013	(85)(104)
T-106	1973	115,000	8/1981	2013	(85)(104)
T-107	1984 r ^a	Not determined. Assumed 2,000	5/1996	2013	(48)(85)(104)
T-108	1974 r ^a	0	11/1978	2013	(104)
T-111	1979, 1994	3,500	2/1995	2014	(56)(85)(104)
TX-105	1977 r ^a	50,000 to 125,000	4/1983	2013	(48)(85)(105)
TX-107	1984	1,300	10/1979	2013	(85)(105)
TX-110	1977 r ^a	0	04/1983	2013	(48)(85)(105)
TX-114	1974	~7,000	4/1983	2013	(48)(85)(105)
TX-117	1977 r ^a	0	3/1983	2013	(48)(85)(105)
TY-101	1973 r ^a	0	4/1983	2010	(59)
TY-103	1973	3,600	2/1983	2010	(59)(85)
TY-104	1981	1,400	11/1983	2010	(59)(85)
TY-105	1960	30,000 to 43,000	2/1983	2010	(59)(85)
TY-106	1959	18,000	11/1978	2010	(59)(85)
U-101	1959 r ^a	0 to 30,000	9/1979	2011	(85)(106)
U-104	1961	<109,000	10/1978	2011	(85)(106)
U-110	1975	5,000 to 25,000	12/1984	2011	(85)(106)
U-112	1980	8,500 to 57,000	9/1979	2011	(85)(106)
57 tanks					

HNF-EP-0182
Revision 447

Table 4-3. Assumed Leakers Re-evaluated as Sound via the Leak Assessment Process

Tank (241-)	Assumed Leaker ⁽⁴⁵⁾	Interim Stabilized ⁽⁵¹⁾	Leak Estimate Updated	Notes (see Section 6.1)
A-103	1987	6/1988	2017	(28)(57)
AX-102	1988	9/1988	2017	(79)(57)
AX-104	1977	8/1981	2017	(81)(57)
C-110	1984	5/1995	2016	(30)(102)
C-111	1968	3/1984	2016	(31)(102)
S-104	1968	12/1984	2018	(85)(98)(103)
SX-104	1988	4/2000	2016	(34)(58)
SX-110	1976	8/1979	2010	(35)(58)
T-109	1974	12/1984	2020	(85)(104)
TX-113	1974	4/1983	2021	(48)(85)(105)(114)
TX-115	1977	9/1983	2022	(48)(85)(123)
TX-116	1977	4/1983	2023	(48)(85)(123)
13 tanks				

Table 4-4. DST Leak Volume Estimates

Tank (241-)	Assumed Leaker	Current Annulus Waste Volume (gal)	Interim Stabilized	Leak Estimate Updated	Notes (see Section 6.1)
AY-102	2012	2,000	N/A	2023	(1)(60)(85)
1 tank					

4.2 WATER INTRUSION IN SINGLE-SHELL TANKS

Since November 2012, all SST videos (excluding those for retrieval activities) have included evaluation of the tank for water intrusion. Table 4-5 lists those tanks currently identified as having an intrusion. To be included on this list, an SST must meet one of three criteria:

1. An intrusion is observed entering the tank during inspection or subsequent video reviews.
2. An intrusion is not observed during a visual inspection. Liquid is covering at least part of the waste surface, comparison to past in-tank images shows an increase in visible liquid, and the surface or interstitial liquid level have an increasing trend.
3. An intrusion is not observed during the visual inspection. Trending of in-tank level data shows an increasing trend, and an evaluation concludes that the trend is due to water intrusion.

Table 4-5. Single-Shell Tanks with Confirmed Water Intrusion (2 pages)

Tank (241-)	Date of Video Inspection ^a or Evaluation	Notes (see Section 6.1)
A-102	1/21/2014	(86)
B-103	11/28/2018	(111)
B-112	1/4/2019	(111)
B-201	2/1/2016	(94)
B-202	1/28/2014	(86)
BX-101	3/11/2013	(86)
BX-103	3/25/2013	(86)
BX-104	11/1/2018	(111)
BX-107	5/22/2017	(95)
BX-110	2/27/2013	(86)
BY-102	12/28/2012	(86)
BY-103	2/25/2014	(86)
BY-109	5/4/2017	(95)
C-201	3/10/2022	(118)
C-202	3/16/2022	(118)
C-203	3/22/2022	(118)
C-204	3/28/2022	(118)
S-102	3/1/2022	(117)
S-106	3/4/2014	(86)
S-107	2/20/2018	(122)
SX-101	12/14/2017	(97)
SX-102	11/21/2013	(86)
SX-106	04/15/2013	(86)
SX-112	2/21/2020	(112)

Table 4-5. Single-Shell Tanks with Confirmed Water Intrusion (2 pages)

Tank (241-)	Date of Video Inspection ^a or Evaluation	Notes (see Section 6.1)
T-101	3/10/2014	(86)
T-107	1/4/2016	(94)
T-111	12/30/2013	(86)
T-201	3/26/2014	(86)
TX-101	4/22/2024	(126)
TY-102	3/7/2014	(86)
TY-104	2/12/2020	(112)
U-101	7/30/2019	(111)
U-102	11/1/2016	(94)
U-105	11/3/2016	(94)
U-109	5/16/2019	(111)
U-111	2/19/2014	(86)
36 tanks		
^a November 2012 and later inspections only, retrieval-related inspections not included.		

Table 4-6 lists SSTs identified as having an intrusion in recent years, but the intrusion is not confirmed as currently continuing. To be included in Table 4-6 an SST must meet the following criterion:

1. An intrusion is not observed during inspection. Liquid is covering at least part of the waste surface, comparison to past in-tank images shows an increase in visible liquid, but the surface level or interstitial liquid level are either unavailable or inconclusive as to whether an intrusion is occurring.

Table 4-6. Single-Shell Tanks with Evidence of Recent Water Intrusion

Tank (241-)	Date of Video Inspection ^a	Notes (see Section 6.1)
A-103	1/21/2014	(86)
B-106	11/25/2020	(120)
B-109	1/28/2014	(86)
BY-101	3/11/2013	(86)
BY-105	11/10/2016	(94)
S-105	10/24/2016	(94)
S-111	3/25/2013	(86)
TX-108	3/18/2015	(88)
8 tanks		
^a November 2012 and later inspections only, retrieval-related inspections not included.		

5.0 MISCELLANEOUS UNDERGROUND STORAGE TANKS AND SPECIAL SURVEILLANCE FACILITIES

Table 5-1 and Table 5-2 reflect miscellaneous underground storage tanks and special surveillance facilities in the 200 East and 200 West Areas, respectively, which have traditionally been managed by the tank farms operating contractor. Assignment of stewardship responsibility has been determined in most cases and currently 84 of the 94 tanks and facilities listed in Table 5-1 and Table 5-2 are owned by the tank farms operating contractor. In HNF-EP-0182, *Waste Tank Summary Report for Month Ending August 31, 2014* (Rev. 320), the volume estimates and other information in Tables 5-1 and 5-2 were revised per RPP-RPT-58156, *Basis for Miscellaneous Underground Storage Tanks and Special Surveillance Facilities Waste Volumes Published in HNF-EP-0182 Revision 320 "Waste Tank Summary Report for Month Ending August 31, 2014"*. Starting with revision 346, the volumes for 31 of the tanks/facilities in Tables 5-1 and 5-2 are updated quarterly with current volume and date information.

Table 5-1. 200 East Area Miscellaneous Underground Storage Tanks and Special Surveillance Facilities (4 pages)

Facility	Location	Received Waste From	Nominal Volume of Remaining Waste (kgal ^a)	Volume Date	Status	Notes (see Section 6.1)
204-AR/ 204-AR-TK-1	West of A Farm complex	Liquid waste from 100 Area, 300 Area rail and highway tankers	0.71	3/22/2009	--	(69)
204-AR/ 204-AR-Sump	West of A Farm complex	Liquid waste from 100 Area, 300 Area rail and highway tankers	No data	--	--	(69)
209-E-TK-111	209-E Building	Decon catch tank	No data	--	--	--
241-A-302-A ^b	South of PUREX bldg. 202A	A-151 diversion box	0.8	12/31/2024	WI	(91)(109)
241-A-302-B ^b	A Farm	A-152 diversion box	4.9	12/2/2024	WI	(91)(109)
241-A-350 ^b	A Farm	Collects drainage	< 0.10	12/4/2024	WI	(91)(109)
241-A-417 ^b	A Farm	Condensate/drainage from A and AX Farm Tanks and other related facilities	1.5	12/4/2024	WI	(91)(109)
241-AX-IX	AX Farm	702-A tank vapor condensate collected in tank 241-A-417	No data	--	--	--
241-AX-151 catch tank	North of PUREX	PUREX Plant	2.8	8/2/2006	--	(68)
241-AX-151 (4 diverter tanks)	North of PUREX	PUREX Plant	No data	--	--	(68)

HNF-EP-0182
Revision 447**Table 5-1. 200 East Area Miscellaneous Underground Storage Tanks and Special Surveillance Facilities (4 pages)**

Facility	Location	Received Waste From	Nominal Volume of Remaining Waste (kgal ^a)	Volume Date	Status	Notes (see Section 6.1)
241-AX-152 catch tank ^b	AX Farm	AX-152 diversion box, AX-151 diverter	< 0.10	11/26/2024	--	(77)(91)
241-AX-152 (2 diverter tanks)	AX Farm	AX-152 diversion box	No data	--	--	(77)
241-AZ-151 ^b	AZ Farm	AZ-702 condensate	4.4	12/4/2024	WI	(91)(109)
241-AZ-154	AZ Farm	AZ-101 and AZ-102 steam condensate	< 0.10	7/31/2008	--	--
241-AZ-301	AZ Farm	AZ-702 condensate	N/A	--	--	(71)(91)
241-B-301-B	B Farm	B-151, B-152, B-153, B-252 diversion box	0.54	4/24/1985	--	--
241-B-302-B	B Farm	B-154 diversion box	5.0	5/10/1985	--	--
241-BX-302-A	BX Farm	BX-152, BX-153, BXR-152, BYR-152 diversion box	0.83	3/14/1984	--	--
241-BX-302-B	BX Farm	BX-154 diversion box	1.0	5/8/1985	--	--
241-BX-302-C	BX Farm	BX-155 diversion box	0.84	4/11/1985	--	--
241-BY-ITS1-TK 1 (SSCT)	BY Farm	Scrub Solutions Circulation Tank	0.35	12/10/2006	--	--
241-BY-ITS1-TK 2	BY Farm	Ion Exchange feed tank	0.0	12/4/2006	--	--
241-BY-ITS2-TK 1	BY Farm	Vapor condenser	No data	--	--	--
241-BY-ITS2-TK 2	BY Farm	Heater flush tank	0.78	8/24/2006	--	--
241-C-301-C	C Farm	C-151, C-152, C-153, C-252 diversion box	13.0	5/11/2018	--	(96)
241-ER-311 ^b	Southwest of B Plant	ER-151, ER-152 diversion box	< 0.10	12/5/2024	--	(63)(91)
241-ER-311A	Southwest of B Plant	ER-151 diversion box	Empty	--	--	--
244-A-TK ^b	A Farm complex	DCRT (receives from several locations)	4.6	12/4/2024	WI	(91)(109)
244-A-Sump ^b	A Farm complex	DCRT (receives from several locations)	< 0.10	12/4/2024	--	(91)
244-AR Vault/TK-244-AR-001 ^b	A Farm complex	A and AX Farms	0.1	12/4/2024	--	(72)(91)

Table 5-1. 200 East Area Miscellaneous Underground Storage Tanks and Special Surveillance Facilities (4 pages)

Facility	Location	Received Waste From	Nominal Volume of Remaining Waste (kgal ^a)	Volume Date	Status	Notes (see Section 6.1)
244-AR Vault/ Sump-AR-001 ^b	A Farm complex	Process jumper connection leaks or cell decon washdowns	< 0.10	12/4/2024	--	(72)(91)
244-AR Vault/ TK-244-AR-002 ^b	A Farm complex	A and AX Farms	< 0.10	12/4/2024	--	(72)(91)
244-AR Vault/ Sump-AR-002 ^b	A Farm complex	Process jumper connection leaks or cell decon washdowns	< 0.10	12/4/2024	--	(72)(91)
244-AR Vault/ TK-244-AR-003 ^b	A Farm complex	A and AX Farms	0.3	12/4/2024	WI	(72)(91)(109)
244-AR Vault/ Sump-AR-003 ^b	A Farm complex	Process jumper connection leaks or cell decon washdowns	< 0.10	11/28/2023	WI	(72)(91)(109)
244-AR Vault/ TK-244-AR-004 ^b	A Farm complex	A and AX Farms	< 0.10	12/4/2024	--	(72)(91)
244-BX-TK ^b	BX Farm complex	B, BX, and BY Farm saltwells	11	12/5/2024	--	(91)
244-BX-Sump ^b	BX Farm complex	B, BX, and BY Farm saltwells	< 0.10	12/5/2024	--	(91)
244-BXR Vault/ TK-BXR-001	BX Farm	BX Farm and diversion boxes	4.1	11/1984	--	--
244-BXR Vault/ Sump-BXR-001	BX Farm	Process jumper connection leaks or cell decon washdowns	< 0.10	4/1984	--	--
244-BXR Vault/ TK-BXR-002	BX Farm	BX Farm and diversion boxes	1.1	2/20/1985	--	--
244-BXR Vault/ Sump-BXR-002	BX Farm	Process jumper connection leaks or cell decon washdowns	< 0.10	2/1985	--	--
244-BXR Vault/ TK-BXR-003	BX Farm	BX Farm and diversion boxes	0.79	2/18/1985	--	--
244-BXR Vault/ Sump-BXR-003	BX Farm	Process jumper connection leaks or cell decon washdowns	7.2	2/18/1985	--	--
244-BXR Vault/ TK-BXR-011	BX Farm	BX Farm and diversion boxes	4.0	4/1984	--	--
244-BXR Vault/ Sump-BXR-011	BX Farm	Process jumper connection leaks or cell decon washdowns	7.6	1/24/1985	--	--

HNF-EP-0182
Revision 447**Table 5-1. 200 East Area Miscellaneous Underground Storage Tanks and Special Surveillance Facilities (4 pages)**

Facility	Location	Received Waste From	Nominal Volume of Remaining Waste (kgal ^a)	Volume Date	Status	Notes (see Section 6.1)
244-CR Vault/ TK-CR-001 ^b	C Farm	B, BX, BY, C Farm sludge slurry	6.9	12/5/2024	WI	(70)(91)(93)(109)
244-CR Vault/ Sump-CR-001	C Farm	Process jumper connection leaks or cell decon washdowns	< 0.10	3/3/2010	--	(70)
244-CR Vault/ TK-CR-002	C Farm	244-CR Vault Tank CR-001	0.75	11/29/2004	--	(70)
244-CR Vault/ Sump-CR-002	C Farm	Process jumper connection leaks or cell decon washdowns	< 0.10	3/09/2010	--	(70)
244-CR Vault/ TK-CR-003 ^b	C Farm	Former C Farm saltwell receiver tank	2.7	12/5/2024	WI	(70)(91)(109)
244-CR Vault/ Sump-CR-003	C Farm	Process jumper connection leaks or cell decon washdowns	< 0.10	3/10/2010	--	(70)
244-CR Vault/ TK-CR-011	C Farm	244-CR Vault Tanks CR-002 and CR-003	4.0	11/30/2004	--	(70)
244-CR Vault/ Sump-CR-011	C Farm	Process jumper connection leaks or cell decon washdowns	< 0.10	2/25/2010	--	(70)

^a Nominal volume of remaining waste is in kgal, unless noted otherwise.^b These MUSTs are monitored and updated on a quarterly basis.

DCRT = double-contained receiver tank.

HVAC = heating, ventilation, and air conditioning.

Volumes $0 < x < 100$ gallons = < 0.10 kgalVolumes $100 \leq x < 1,000$ gallons = Two decimal place kgal

PUREX = plutonium/uranium extraction.

WI = water intrusion

MUST = miscellaneous underground storage tank

Volumes $x \geq 1,000$ gallons = One decimal place kgal"

"empty" = "No data"

Table 5-2. 200 West Area Miscellaneous Underground Storage Tanks and Special Surveillance Facilities (3 pages)

Facility	Location	Received Waste From	Nominal Volume of Remaining Waste (kgal ^a)	Volume Date	Status	Notes (see Section 6.1)
213W-TK-1	East of 213-W Compactor Facility	Water retention tank	1.6	3/19/1999	--	--
231-W-151-001	North of Z Plant	231-Z floor drains	1.4	8/15/1974	--	--
231-W-151-002	North of Z Plant	231-Z floor drains	0.96	8/15/1974	--	--
240-S-302 ^b	North of REDOX Plant	240-S-151 diversion box	1.7	12/16/2024	--	(64)(91)
241-E/W-151 Vent Station Catch Tank ^b	South of 609-A	Cross-site transfer lines/encasement	0.5	12/16/2024	WI	(66)(91)(109)
241-S-302A	S Farm	S-151 diversion box	0.30	3/19/2001	--	(82)
241-S-302B	SX Farm	S encasements	< 0.10	4/1984	--	--
241-S-304 ^b	S Farm	S-151 diversion box	0.13	12/16/2024	--	(91)
241-SX-302	SX Farm	SX-151 diversion box, SX-152 transfer box	1.4	11/1984	--	--
241-T-301	T Farm	T-151, T-152, T-153, T-252 diversion box	22.0	7/3/1985	--	--
241-TX-302A	TX Farm	TX-153 diversion box	2.5	8/1984	--	--
241-TX-302B ^b	East of TX Farm	TX-155 diversion box	2	12/16/2024	WI	(83)(91)(109)
241-TX-302-B(R)	East of TX Farm	TX-155 diversion box	No data	--	--	(83)
241-TX-302C ^b	T Plant	TX-154 diversion box	3.7	12/16/2024	WI	(91)(92)(109)
241-TX-302-X-B	TX Farm	TX encasements	0.34	8/1984	--	--
241-TY-302A	TY Farm	TY-153 diversion box	0.46	6/25/1985	--	--
241-TY-302B	TY Farm	TY encasements	< 0.10	8/1984	--	--
241-U-301B ^{b,c}	U Farm	U-151, U-152, U-153, U-252 diversion box	1.5	12/16/2024	WI	(91)(109)
241-UX-302A ^b	U Plant	UX-154 diversion box	0.25	12/31/2024	WI	(65)(91)(109)
241-Z-8 (216-Z-8)	East of Z Plant	RECUPLEX	0.50	10/19/1974	--	--
242-S TK C-100	242-S Evaporator	242-S Evaporator process condensate	8.0	--	--	--
242-T-135	T Evaporator	T Evaporator	No data	--	--	(76)

HNF-EP-0182
Revision 447**Table 5-2. 200 West Area Miscellaneous Underground Storage Tanks and Special Surveillance Facilities (3 pages)**

Facility	Location	Received Waste From	Nominal Volume of Remaining Waste (kgal ^a)	Volume Date	Status	Notes (see Section 6.1)
242-TA-R1	T Evaporator	Z Plant	No data	--	--	(75)
242-TA-Sump	T Evaporator	Z Plant	< 0.10	9/24/2010	--	(75)
243-S-TK-1	Northwest of S Farm	Personnel decontamination facility	No data	--	--	--
244-S-TK ^b	S Farm	From SSTs for transfer to Tank SY-102	5.1	12/16/2024	--	(91)
244-S-Sump ^b	S Farm	From SSTs for transfer to Tank SY-102	< 0.10	12/28/2016	--	(91)
244-TX-TK ^b	TX Farm	Z Plant	8.3	12/16/2024	WI	(91)(109)
244-TX-Sump ^b	TX Farm	Z Plant	< 0.10	5/23/2023	--	(91)
244-TXR Vault/ TK-TXR-001	TX Farm	Transfer lines, TXR-151 diversion box	0.47	10/1984	--	--
244-TXR Vault/ Sump-TXR-001	TX Farm	Process jumper connection leaks or cell decon washdowns	< 0.10	10/1984	--	--
244-TXR Vault/ TK-TXR-002	TX Farm	Transfer lines	1.9	10/1984	--	--
244-TXR Vault/ Sump-TXR-002	TX Farm	Process jumper connection leaks or cell decon washdowns	0.10	10/1984	--	--
244-TXR Vault/ TK-TXR-003	TX Farm	Transfer lines	5.3	10/1984	--	--
244-TXR Vault/ Sump-TXR-003	TX Farm	Process jumper connection leaks or cell decon washdowns	< 0.10	10/1984	--	--
244-U-TK	U Farm	U Farm saltwell liquids	1.9	11/3/2010	--	--
244-U-Sump	U Farm	Process jumper connection leaks or cell decon washdowns	No data	--	--	(84)
244-UR Vault/ TK-UR-001	U Farm	U Farm	0.42	7/1984	--	--

Table 5-2. 200 West Area Miscellaneous Underground Storage Tanks and Special Surveillance Facilities (3 pages)

Facility	Location	Received Waste From	Nominal Volume of Remaining Waste (kgal ^a)	Volume Date	Status	Notes (see Section 6.1)
244-UR Vault/ Sump-UR-001	U Farm	Process jumper connection leaks or cell decontamination washdowns	1.2	6/26/1984	--	--
244-UR Vault/ TK-UR-002	U Farm	U Farm	1.5	7/11/1984	--	--
244-UR Vault/ Sump-UR-002	U Farm	Process jumper connection leaks or cell decontamination washdowns	< 0.10	7/8/1984	--	--
244-UR Vault/ TK-UR-003	U Farm	U Farm	0.60	7/1984	--	--
244-UR Vault/ Sump-UR-003	U Farm	Process jumper connection leaks or cell decontamination washdowns	3.4	6/21/1984	--	--
244-UR Vault/ 244-UR-004	U Farm	U Farm	No data	--	--	(74)

^a Nominal volume of remaining waste is in kgal, unless noted otherwise.

^b These MUSTs are monitored and updated on a quarterly basis.

^c Equipment failure

RECUPLEX = recovery of uranium and plutonium by extraction.
WI = water intrusion

Volumes $0 < x < 100$ gallons = < 0.10 kgal
Volumes $100 \leq x < 1,000$ gallons = Two decimal place kgal

REDOX = reduction-oxidation.
SST = single-shell tank.

Volumes $x \geq 1,000$ gallons = One decimal place kgal
“empty” = “No data”

This page intentionally left blank.

6.0 ENDNOTES AND REFERENCES

6.1 REPORT ENDNOTES

Table 6-1 includes endnotes for the tables found in Sections 1.0 through 5.0 of this report. When an endnote is referenced multiple times, the location column shows each table referencing the endnote.

The following endnotes have been deleted from this report: 2, 3, 7, 36-42, 43-44, 46-47, 49-50, 53-55, 61-62, 67, 73, 78, 80, 87, and 107. Some of the deleted end notes for Table 4-2 were consolidated into new footnotes. The original endnote numbering has been retained; deleted endnote numbers have been retired to maintain consistency with the numbering of the remaining endnotes and traceability with earlier revisions of this report.

Table 6-1. Waste Tank Summary Report Endnotes (11 pages)

No.	Comment/Reference	Location
(1)	RPP-ASMT-53793, <i>Tank 241-AY-102 Leak Assessment Report</i> , states that Tank AY-102 was declared an “Assumed Leaker – Primary Tank” on October 19, 2012, due to the results of a leak assessment performed on discovery of waste material in the tank’s annulus space. The ORP (Office of River Protection) was notified of the intention to change the tank’s leak integrity classification (Clark 2012).	Table 1-1, Table 4-3
(4)	SSTs in retrieval – Tanks with active bulk or heel retrieval operations in progress or awaiting heel retrieval.	Table 1-1

Table 6-1. Waste Tank Summary Report Endnotes (11 pages)

No.	Comment/Reference	Location
(5)	<p>Retrieval operations complete – Tanks have active retrieval operations completed (e.g., Tanks C-101, C-102, C-103, C-104, C-105, C-106, C-107, C-108, C-109, C-110, C-111, C-112, C-201, C-202, C-203, C-204, S-112, AX-102 and AX-104); retrieval data report and/or retrieval completion certification have been provided to ORP for review and submittal to Ecology.</p> <p>Letter of Completion for Retrieval Data Report (from ORP to Ecology) for the following tanks:</p> <ul style="list-style-type: none"> • Tank C-101 (letter 15-TF-0099, dated September 24, 2015 [Smith 2015b]) • Tank C-102 (letter 16-TF-0115, dated October 11, 2016 [Smith 2016b]) • Tank C-103 (letter 07-TPD-026, dated May 21, 2007 [Olinger 2007a]) • Tank C-104 (letter 14-TF-0013, dated February 18, 2014 [Smith 2014e]) • Tank C-105 (letter 19-TPD-0011, dated June 21, 2019 [Vance 2019]) • Tank C-106 (letter 20-ECD-0016, dated April 1, 2020 [Vance 2020]) • Tank C-107 (letter 15-TF-0086, dated September 14, 2015 [Smith 2015d]) • Tank C-108 (letter 13-TF-0120, dated November 27, 2013 [Smith 2013b]) • Tank C-109 (letter 14-TF-0020, dated March 13, 2014 [Smith 2014f]) • Tank C-110 (letter 14-TF-0086, dated August 6, 2014 [Smith 2014g]) • Tank C-111 (letter 17-TPD-0018, dated August 11, 2017 [Smith, 2017c]) • Tank C-112 (letter 15-TF-0098, dated September 30, 2015 [Smith 2015c]) • Tank C-201 (letter 06-TPD-071, dated November 2, 2006 [Schepens 2006b]) • Tank C-202 (letter 06-TPD-051, dated July 31, 2006 [Schepens 2006c]) • Tank C-203 (letter 06-TPD-005, dated January 18, 2006 [Schepens 2006d]) • Tank C-204 (letter 07-TPD-043, dated August 9, 2007 [Olinger 2007b]) • Tank S-112 (letter 07-TPD-066, dated December 21, 2007 [Olinger 2007c]) • Tank AX-102 (letter 22-TF-002556, dated September 6, 2022 [Vance, 2022]) 	Table 1-1, Table 2-1
	<p>Retrieval completion certifications provided by ORP to Ecology for the following tanks:</p> <ul style="list-style-type: none"> • Tank AX-102 (letter 21-TF-002570, dated September 13, 2021 [Vance, 2021]) • Tank AX-103 (letter 23-TF-000067, dated January 17, 2023 [Vance, 2023]) • Tank AX-104 (letter 22-TF-002824, dated September 29, 2022 [Vance, 2022]) • Tank C-101 (letter 14-TF-0113, dated September 24, 2014 [Smith 2014b]) • Tank C-102 (letter 15-TF-0116, dated November 30, 2015 [Smith 2015a]) • Tank C-104 (letter 13-TF-0018, dated March 21, 2013 [Fletcher 2013a]) • Tank C-105 (letter 18-TF-0044, dated June 28, 2018 [Vance 2018]) • Tank C-107 (letter 14-TF-0114, dated September 30, 2014 [Smith 2014c]) • Tank C-108 (letter 13-TF-0025, dated May 1, 2013 [Fletcher 2013b]) • Tank C-109 (letter 13-TF-0037, dated June 4, 2013 [Smith 2013a]) • Tank C-110 (letter 14-TF-0007, dated January 29, 2014 [Smith 2014a]). • Tank C-112 (letter 14-TF-0115, dated September 30, 2014 [Smith 2014d]) • Tank C-111 (letter 16-TF-0090, dated August 29, 2016 [Smith 2016a]) <p>Completion of retrieval activities per the 241-AY-102 Settlement Agreement provided by ORP and WRPS to Ecology:</p> <ul style="list-style-type: none"> • Tank AY-102 (Letter 17-TF-0021, dated February 23, 2017 [Smith 2017a]) • Tank AY-102 (Letter 17-TF-0030, dated March 13, 2017 [Smith 2017b]) 	

Table 6-1. Waste Tank Summary Report Endnotes (11 pages)

No.	Comment/Reference	Location
(6)	Retrieval operations complete and in review – Tank(s) have active retrieval operations completed report or practicability evaluation is pending approval; or evaluation has been accepted, but final completion letter or certification submittal is pending.	Table 1-1
(8)	Nominal volume of waste inventory is the best estimate of residual volume. Retrieval data reports also provide 95 percent upper confidence level volume as the bounding estimate of remaining waste. For retrieval in progress tanks nominal value may include water used for sluicing.	Table 2-1
(9)	Tank C-101 nominal waste volume – Total waste 4,995 gal (RPP-CALC-56434, <i>Post-Retrieval Camera/CAD Modeling System Waste Volume Estimate for Tank 241-C-101</i>) revised to 5.5 kgal (RPP-RPT-54440, <i>Derivation of Best-Basis Inventory for Tank 241-C-101 as of October 1, 2023</i>)	Table 2-1, Table 4-1
(10)	Tank C-102 nominal waste volume estimate – Total waste 15.5 kgal (RPP-RPT-57458, <i>Derivation of Best-Basis Inventory for tank 241-C-102 as of January 1, 2023</i>)	Table 2-1, Table 4-1
(11)	Tank C-103 nominal waste volume – Total waste 2,529 gal, sludge 2,282 gal, supernatant 247 gal (RPP-RPT-33060, <i>Retrieval Data Report for Single-Shell Tank 241-C-103</i> and, <i>RPP-RPT-59973, Derivation of Best-Basis Inventory for Tank 241-C-103 as of January 1, 2023</i>).	Table 2-1, Table 4-1
(12)	Tank C-104 nominal waste volume – Total waste 1.9 kgal of sludge (RPP-RPT-46616, <i>Derivation of Best-Basis Inventory for Tank 241-C-104 as of July 1, 2023</i>).	Table 2-1, Table 4-1
(13)	Tank C-105 nominal waste volume estimate – Total Waste is 1.5 kgal of sludge (RPP-RPT-58071, <i>Derivation of Best-Basis Inventory for Tank 241-C-105 as of July 1, 2023</i> , and RPP-RPT-60731, <i>Post-Retrieval Camera/CAD Modeling System Waste Volume Estimate for Tank 241-C-105</i>).	Table 2-1, Table 4-1
(14)	Tank C-106 nominal waste volume – Total waste 2,369 gal sludge. (RPP-RPT-60124, <i>Derivation of Best-Basis Inventory for Tank 241-C-106 as of October 1, 2023</i>). DOE declared C-106 retrieval complete in letter 20-ECD-0016 dated 4/1/20 (20-ECD-0016, Letter, B.T. Vance, ORP, to A.K. Smith, Ecology, and D. Einan, EP“, "U.S. Department of Energy Rescinds “Request for Waiver to Hanford Federal Facility Agreement and Consent Order Waste Retrieval Criteria for Single Shell Tank 241-C-106,” dated April 1, 2020). As stated in the letter, recent calculations confirm that the retrieval goal of 360 cubic feet has been met for C-106.	Table 2-1, Table 4-1
(15)	Tank C-107 waste volume estimate – Total waste 10 kgal of sludge (RPP-RPT-48745, Rev. 10, <i>Derivation of Best-Basis Inventory for Tank 241-C-107 as of July 1, 2023</i>).	Table 2-1, Table 4-1
(16)	Tank C-108 nominal waste volume – Total waste 3.4 kgal sludge (RPP-RPT-45147, <i>Derivation of Best-Basis Inventory for Tank 241-C-108 as of July 1, 2023</i>).	Table 2-1, Table 4-1
(17)	Tank C-109 nominal waste volume – Total waste 2.0 kgal (RPP-RPT-51343, <i>Derivation of Best-Basis Inventory for Tank 241-C-109 as of July 1, 2023</i>).	Table 2-1, Table 4-1
(18)	Tank C-110 nominal waste volume – Total waste 2.1 kgal (RPP-RPT-49876, <i>Derivation of Best-Basis Inventory for Tank 241-C-110 as of October 1, 2024</i>).	Table 2-1, Table 4-1
(19)	Tank C-111 volume estimate – Total waste 4.9 kgal (RPP-RPT-59377, <i>Post-Retrieval Camera/CAD Modeling System Waste Volume Estimate for Tank 241-C-111</i> and RPP-RPT-48459, <i>Derivation of Best-Basis Inventory for Tank 241-C-111 as of October 1, 2023</i>).	Table 2-1, Table 4-1

Table 6-1. Waste Tank Summary Report Endnotes (11 pages)

No.	Comment/Reference	Location
(20)	Tank C-112 waste volume estimate – Total waste 12,700 gal (RPP-CALC-56856, <i>Estimated Waste Volume Remaining in Single-Shell Tank 241-C-112 after Hard Heel Retrieval</i>); revised to 10,000 gal (RPP-RPT-52516, <i>Derivation of Best-Basis Inventory for Tank 241-C-112 as of October 1, 2023</i>).	Table 2-1, Table 4-1
(21)	Tank C-201 nominal waste volume – Total waste 368 gal, sludge 142 gal, supernatant 226 gal (RPP-29441, <i>Post-Retrieval Waste Volume Determination for Single-Shell Tank 241-C-201</i> and RPP-RPT-58929, <i>Derivation of Best-Basis Inventory for Tank 241-C-201 as of May 1, 2022</i>).	Table 2-1, Table 4-1
(22)	Tank C-202 nominal waste volume – Total waste 353 gal, sludge 145 gal, supernatant 208 gal (RPP-RPT-29095, <i>Retrieval Data Report for Single-Shell Tank 241-C-202</i> and RPP-RPT-59855, <i>Derivation of Best-Basis Inventory For Tank 241-C-202 as of May 1, 2022</i>).	Table 2-1, Table 4-1
(23)	Tank C-203 nominal waste volume – Total waste 348 gal, sludge 126 gal, supernatant 222 gal (RPP-RPT-26475, <i>Retrieval Data Report for Single-Shell Tank 241-C-203</i> and RPP-RPT-59860, <i>Derivation of Best-Basis Inventory for Tank 241-C-203 as of May 1, 2022</i>).	Table 2-1, Table 4-1
(24)	Tank C-204 nominal waste volume – Total waste 137 gal, sludge 134 gal, supernatant 3 gal (RPP-RPT-34062, <i>Retrieval Data Report for Single-Shell Tank 241-C-204</i>).	Table 2-1, Table 4-1
(25)	Tank S-112 nominal waste volume – Total waste 2,667 gal, sludge 2,543 gal, supernatant 124 gal (RRP-RPT-60377, <i>Derivation of Best-Basis Inventory for Tank 241-S-112 as of October 1, 2021</i>).	Table 2-1, Table 4-1
(26)	For some tanks, a volume difference exists between estimates published in HNF-SD-RE-TI-178, <i>Single-Shell Tank Interim Stabilization Record</i> , and later TWINS estimates. TWINS estimates are reported in Table 4-1.	Table 4-1
(27)	Tank A-101 contains retained gas in saltcake; Tanks S-102, S-111, U-103, and U-109 contain retained gas in saltcake and sludge.	Table 4-1
(28)	Status of Tank A-103 changed from “assumed leaker” to “sound” per RPP-ASMT-42278, <i>Tank 241-A-103 Leak Assessment Report</i> .	Table 4-1, Table 4-3
(29)	Status of Tank C-105 changed from “sound” to “assumed leaker” per RPP-ASMT-46452, <i>Tank 241-C-105 Leak Assessment Completion Report</i> . However, there was no indication of a leak from this tank during retrieval.	Table 4-1, Table 4-2
(30)	Status of Tank C-110 changed from “assumed leaker” to “sound” per RPP-ASMT-38219, <i>Tank 241-C-110 Leak Assessment Report</i> . There was no indication of a leak from this tank during retrieval.	Table 4-1, Table 4-3
(31)	Status of Tank C-111 changed from “assumed leaker” to “sound” per RPP-ASMT-39155, <i>Tank 241-C-111 Leak Assessment Report</i> . There was no indication of a leak from this tank during retrieval.	Table 4-1, Table 4-3
(32)	Retrieval operations began in Tank S-102 on December 16, 2004, and were suspended in July 2007. Actions were subsequently taken to reduce the remaining liquid volume to below interim stabilization criteria. A letter was submitted to DOE on June 1, 2010, that stated Tank S-102 again met interim stabilization criteria (Sax 2010).	Table 4-1
(33)	The <i>Hanford Federal Facility Agreement and Consent Order</i> (signed August 2004) modified Milestone M-45-00C (Change Order M-45-04-01) changing the regulatory requirements for retrieval of waste in Tanks S-103, S-105, and S-106 (Ecology et al 1989). “Retrieval” status in these tanks is thereby rescinded.	Table 4-1

Table 6-1. Waste Tank Summary Report Endnotes (11 pages)

No.	Comment/Reference	Location
(34)	Status of Tank SX-104 changed from “assumed leaker” to “sound” per RPP-ASMT-48143, <i>Tank 241-SX-104 Leak Assessment Completion Report</i> . Due to a drop in the interstitial liquid level another leak assessment was performed. RPP-ASMT-63062, <i>Leak Assessment Report for Tank 241-SX-104 Interstitial Liquid Level Anomaly 2017</i> , determined the leak status should remain as “sound”.	Table 4-1, Table 4-3
(35)	Status of Tank SX-110 changed from “assumed leaker” to “sound” per RPP-ASMT-47140, <i>Tank 241-SX-110 Leak Assessment Report</i> .	Table 4-1, Table 4-3
(45)	An “r” follows the year shown for tanks for which re-assessment of the current tank integrity classification is recommended because releases may be attributed to sources other than a tank leak. In many cases, a leak was suspected long before it was identified or confirmed. For example, SD-WM-SAR-006, <i>Single-Shell Tank Isolation Safety Analysis Report</i> , shows that Tank U-104 was suspected of leaking in 1956. The leak was confirmed in 1961. In 1984, the criteria designations of “suspected leaker,” “questionable integrity,” “confirmed leaker,” “declared leaker,” and “borderline and dormant” were merged into one category now reported as “assumed leaker.” Catlin (1980) describes tanks designated as “assumed leakers” in 1980.	Table 4-2, Table 4-3
(48)	Leak volumes for these 19 tanks were previously assumed to be the same as the average leak volume for 18 of the 24 tanks identified in Baumhardt (1989) and Jensen/Merrill (1989). The total leak volume estimate for these tanks was 150 kgal (rounded to the nearest kgal), for an average of approximately 8 kgal for each of 19 tanks. This estimate is highly suspect and the leak/release volume for these tanks is assumed to be “0” except as noted.	Table 4-2, Table 4-3
(51)	These dates indicate when the tanks were declared to be interim stabilized in HNF-SD-RE-TI-178, <i>Single-Shell Tank Interim Stabilization Record</i> . In some cases, the official interim stabilization documents were issued later. Also, in some cases, the field work associated with interim stabilization was completed at an earlier date.	Table 4-2, Table 4-3
(56)	Tank T-111 was declared an “assumed re-leaker” on February 28, 1994, due to a decreasing trend in surface level measurement. This tank was pumped, and interim stabilization was completed on February 22, 1995. RPP-RPT-54964, <i>Evaluation of Tank 241-T-111 Level Data and In-Tank Video Inspection</i> , estimated that from 1995 to January 1, 2014, Tank T-111 leaked approximately 2,500 gal. The value reported in Table 4-2 sums the <1,000 gal reported in 1994, with the approximately 2,500 gal reported in 2013.	Table 4-2
(57)	<p>The bases for tank leak/release volumes in A and AX farms are summarized in RPP-RPT-61279. Leak volumes were estimated for SSTs A-104 and A-105. The leak volume estimate for A-105 includes cooling water.</p> <ul style="list-style-type: none"> WHC-MR-0264, <i>Tank 241-A-105 Leak Assessment</i>, estimates nearly all the 610 kgal of cooling water added to tank A-105 may have evaporated. WHC-EP-0410, <i>Tank 241-A-105 Evaporation Estimate 1970 Through 1978</i>, estimates as little as 378 kgal may have evaporated. The estimated volume of cooling water leaked ranges from 0 to 232 kgal. <p>Integrity assessments were conducted for Tanks A-103, AX-102 and AX-104 which were reclassified as “sound.”</p>	Table 4-2, Table 4-3

Table 6-1. Waste Tank Summary Report Endnotes (11 pages)

No.	Comment/Reference	Location
(58)	<p>The bases for tank leak/release volumes in SX farm are summarized in RPP-RPT-61279. Tanks SX-107, SX-108, SX-109, SX-111, SX-112, SX-113, SX-114 and SX-115 appear to have leaked. The leak volume estimate for tank SX-108 includes water losses.</p> <ul style="list-style-type: none"> Between 1964 and 1970 liquid level decreases equating up to 101,000 gal were observed. The estimated undiluted tank waste leak volume based on Cs-137 vadose zone data was 11,000 gal. The remainder is attributed to water losses to the ground or atmosphere. <p>Integrity assessments were conducted for tanks SX-104 and SX-110, which were reclassified as “sound.”</p>	Table 4-2, Table 4-3
(59)	<p>The bases for tank leak/release volumes in TY farm are summarized in RPP-RPT-61279. Tanks TY-103, 104, 105 and 106 appear to have leaked. An integrity assessment was recommended for tank TY-101.</p>	Table 4-2
(60)	<p>As of 1/1/23 the estimated annulus waste volume is 2,000 gals (RPP-RPT-44630, <i>Derivation of Best-Basis Inventory for Tank 241-AY-102 as of January 1, 2023</i>).</p>	Table 4-4
(61)	<p>A reevaluation of the Tank C-105 leak integrity using TFC-ENG-CHEM-D-42 was completed in May 2010, concluding that a leak from the tank could not be ruled out by the evidence from recently completed Direct Push C7469 and other available data, and recommending that the leak integrity status be revised to “assumed leaker.” The estimated leak volume was <2,000 gal (RPP-ASMT-46452).</p>	Table 4-2
(63)	<p>A leak assessment was performed because of the 0.5-in. liquid level decrease between early October 2005 and January 31, 2006. The leak assessment, issued on March 17, 2006, concluded that a tank leak was the most likely explanation for the level trend (RPP-RPT-29163, <i>Tank 241-ER-311 Leak Assessment Report</i>).</p> <p>The solids volume in the tank is not known. Sample activities conducted during November 1999 concluded that there were approximately 7 to 9 in. of solids beneath the east riser and no solids beneath the west riser (HNF-5985, <i>ER-311 Flammable Gas Response and Findings</i>). The remaining liquid in the tank was evaporated to dryness between October 13, 2006, and February 15, 2007. A subsequent video inspection on March 17, 2007, indicated no remaining free liquid was present (Olinger 2007d). There are ground level 4-inch risers to the tank; one located at the west end (location of the Enraf®) and one at the east end (Location of breather filter) (RPP-RPT-29163).</p>	Table 5-1
(64)	<p>A leak assessment was performed because of a steady, predictable liquid level decrease of approximately 0.33 in./year since the early 1980s. The tank was designated as an “assumed leaker” in 1985 but had no record of a formal leak assessment. The leak assessment report was issued on October 10, 2007 (RPP-ASMT-35057, <i>Tank 240-S-302 Leak Assessment Report</i>).</p> <p>A total of 6,265 gal of supernatant was pumped from the tank between September 21, 2008, and September 28, 2008. A solids level of 14.12 in. (1,361 gal) was measured with an Enraf®¹ densitometer on September 9, 2008. A post-pumping visual inspection showed a small 1-ft wide by 10-ft long pool of liquid centered beneath the pump, corresponding to less than 6 gal of free liquid. The remaining volume is estimated to be 1,360 to 1,660 gal, based on Enraf® and densitometer readings in different risers, and assuming that the solids are level across the tank.</p>	Table 5-2

Table 6-1. Waste Tank Summary Report Endnotes (11 pages)

No.	Comment/Reference	Location
(65)	<p>A leak assessment was performed because of the 0.7-in. level decrease between January 2004 and February 2006. The leak assessment concluded that a tank leak was the most likely explanation for the level trend. The leak assessment report was issued on May 12, 2006 (RPP-RPT-29711, <i>Tank 241-UX-302A Leak Assessment Report</i>).</p> <p>Pumping of the remaining free liquid from the tank was completed October 25, 2006 (Schepens 2006e). An estimated 75 to 110 gal of sludge and 10 gal of free liquid remained in the tank (RPP-RPT-31779, <i>241-UX-302A Catch Tank Liquid Mitigation Completion Report</i>).</p> <p>Following additional liquid intrusion, the tank was pumped August 27, 2009 (RPP-RPT-42789, <i>Completion of Removal of Pumpable Liquid From 241-UX-302A</i>), June 21, 2012, to August 7, 2012 (Work Package TFC-WO-11-5930 WCN-2), May 3, 2015 (Work Order #WO-163708), and November 2, 2016 (Work Order# 218270). Enraf® liquid level readings estimate that approximately 90 gallons of sludge and liquid remain in the tank as 11/2/2016.</p>	Table 5-2
(66)	<p>A leak assessment was performed because of a 1.25-in. liquid level decrease between July 2006 and November 2006. The leak assessment concluded that the level decrease was the result of evaporation from an operating exhauster connected to catch tank 241-ER-311. This was confirmed when the exhauster was shut down and the liquid level stabilized. The tank remains classified as a “sound” tank. The leak assessment report was issued on June 25, 2007 (RPP-ASMT-33741, <i>Tank 241-EW-151 Leak Assessment Report</i>).</p>	Table 5-2
(68)	<p>241-AX-151 consists of four 50-gal diverter tanks (Tanks D – G) located in individual cells and the approximate 12,200-gal capacity 241-AX-151-CT catch tank (stainless steel lined concrete vault and sump) receiving drainage from the pump pit and the four cells.</p>	Table 5-1
(69)	<p>204-AR Customer Waste Unloading Facility includes a 1,500-gal catch tank enclosed in a stainless-steel lined pit and pit sump; combined capacity of the catch tank and pit are 4,550 gal (WHC-SD-WM-SAR-040, <i>Safety Analysis Report for the 204-AR Waste Unloading Facility</i>).</p>	Table 5-1
(70)	<p>244-CR Vault contains two 40-kgal tanks, CR-011 and CR-001, and two 15-kgal tanks, CR-002 and CR-003, in individual cells. The contents of the 244-CR Vault cells were pumped to Tank C-104 during retrieval of Tank C-104. Pumping was completed on March 10, 2010 (RPP-RPT-45845, <i>Completion of Pumpable Liquids Removal from 244-CR Vault</i>). The completion letter was sent to ORP on April 28, 2010 (Dunning 2010). Tank volumes except tank CR-001 and CR-003 are from RPP-RPT-24257, <i>244-CR Vault Liquid Level Assessment and Video Inspection Completion Report</i>. Following WRPS-PER-2012-0724, quarterly monitoring of Tank CR-001 was implemented in April 2013 by installation of an Enraf® monitoring device; the volume is derived from RPP-CALC-24219, <i>244-CR Vault Tank and Cell Volume Calculations</i>.</p>	Table 5-1
(71)	<p>Tank AZ-301 is an active part of the DST system.</p>	Table 5-1
(72)	<p>244-AR vault was interim-stabilized in 2003 (RPP-12051, <i>244-AR Vault Interim Stabilization Completion Report</i>). The tanks and cell sumps in the 244-AR Vault are monitored quarterly for signs of intrusion.</p>	Table 5-1
(74)	<p>Records in the waste information data system indicate that Tank 244-UR-004 did not contain radioactive material. The tank was used to stage nitric acid to the other 244-UR vault tanks during the uranium recovery process in the 1950s.</p>	Table 5-2

Table 6-1. Waste Tank Summary Report Endnotes (11 pages)

No.	Comment/Reference	Location
(75)	On August 1, 2002, a video surveillance at the 242-TA receiver vault revealed that catch tank TA-R1 was floating off its foundation due to liquid at a depth of approximately 10 ft in the vault. It was observed that associated piping was damaged. Approximately 7,000 gal of liquid had accumulated in the vault. Pumping the liquid from the vault and resealing the cover plate to prevent further intrusion were completed November 26, 2003. The remaining liquid volume in the vault was not reported (Occurrence Report RP-CHG-TANKFARM-2002-0083, "Video Surveillance Reveals Catch Tank TA-R1 Floating Off of Its Foundation at 242-TA Vault").	Table 5-2
(76)	Video surveillance of 242-T-135 was prompted by the discovery of approximately 7,000 gal of water in the 242-TA receiver vault on August 1, 2002. There was no report of water present (Occurrence Report RP—CHG-TANKFARM-2002-0083).	Table 5-2
(77)	Removed from service on March 23, 2001 (Occurrence Report RP-CHG-TANKFARM-2001-0014, "Catch Tank 152-AX Was Identified as a Potential Leaking Tank").	Table 5-1
(79)	Tank AX-102 integrity status was changed from "assumed leaker" to "sound" per RPP-ASMT-42628, <i>Tank 241-AX-102 Integrity Assessment Report</i> .	Table 4-3
(81)	Tank AX-104 integrity status was changed from "assumed leaker" to "sound" per RPP-ASMT-57574, <i>Tank 241-AX-104 Integrity Assessment Report</i> .	Table 4-3
(82)	Partially filled with grout February 1991, determined to be an assumed leaker after leak tests. No surface level or intrusion readings obtainable. Tank S-304 replaced 241-S-302A.	Table 5-2
(83)	241-TX-302-B® replaced 241-TX-302B and a new 241-TX-302B later replaced 241-TX-3®(R).	Table 5-2
(84)	244-U-TK and 244-U-Sump were never placed in service. Per RPP-RPT-58156, "Tank 244-U was originally intended as the saltwell receiver for 241-U tank farm tanks. However, the tank was bypassed and never received saltwell waste."	Table 5-2
(85)	<p>The following references provide additional information for the listed tanks:</p> <ul style="list-style-type: none"> • Baumhardt, 1989: Tank B-101, B-103, B-105, B-107, B-110, B-111, B-112, B-203, B-204, BX-101, BX-102, BX-108, BX-110, BX-111, BY-105, BY-106, BY-107, C-101, C-203, S-104, SX-111, SX-112, SX-113, SX-114, T-103, T-106, T-107, T-109, TX-105, TX-107, TX-110, TX-113, TX-114, TX-115, TX-116, TX-117, TY-103, TY-104, TY-105, TY-106, U-101, U-104, U-110, and U-112 • Clark, 2012, Tank AY-102 • Tank AY-102 Monthly Monitoring Reports: RPP-RPT-59566, RPP-RPT-59601, RPP-RPT-59683, RPP-RPT-59728, RPP-RPT-59792, RPP-RPT-59885, RPP-RPT-59836, RPP-RPT-60196, RPP-RPT-60344, RPP-RPT-60241, RPP-RPT-60435, RPP-RPT-60584, RPP-RPT-60713 • Groth, 1987: Tanks C-201, C-202, and C-204 • PNL-4688, 1983: Tanks A-104, BY-103, BY-108, and SX-107 • RHO-RE-SR-14, 1984: Tank B-201 • RPP-ASMT-46452, 2010: Tank C-105 • HNF-3233, 1998: Tanks SX-108, SX-109, SX-111 and SX-112 • RPP-RPT-54964, 2014: Tank T-111 • WHC-MR-0300, 1992: Tank SX-108 • WHC-MR-0301, 1992: Tank SX-109 • WHC-MR-0302, 1992: Tank SX-115 • RPP-CALC-66615, 2024: Tank T-101 • WHC-TANKFARM-1994-0009, 1994: Tank T-111 	Table 4-2, Table 4-3, Table 4-4

Table 6-1. Waste Tank Summary Report Endnotes (11 pages)

No.	Comment/Reference	Location
(86)	See RPP-RPT-50799, 2015, <i>Suspect Water Intrusion in Single-Shell Tanks</i> , Revision 2, for basis for intrusion decision and intrusion rates. Tanks SX-102 and T-111 are only discussed in Appendix B of RPP-RPT-50799 since the videos in these two tanks were obtained for reasons other than intrusion investigation.	Table 4-5, Table 4-6
(88)	See RPP-RPT-58849, 2015, <i>Fiscal Year 2015 Visual Inspection Report for Single-Shell Tanks</i> , Revision 0, for basis for intrusion decision.	Table 4-6
(89)	The Solids Volume Update is the date of the most recent BBI estimate or for tanks undergoing retrieval it is the date of the most recent engineering volume estimate.	Table 4-1
(90)	Tank AY-102 nominal waste volume estimate – Total waste in primary tank is approximately 10,000 gallons as of May 1, 2021. This volume does not include the waste in the annulus (RPP-RPT-44630, <i>Derivation of Best-Basis Inventory for Tank 241-AY-102 as of January 1, 2023</i>).	Table 2-1, Table 4-1
(91)	These 32 tanks are monitored on a quarterly basis per OSD-T-151-00031, <i>Operating Specifications for Tank Farm Leak Detection and Single-Shell Tank Intrusion Detection</i> , Table 4.1, Monitoring Device, Frequency, and Tank Specification Limits for MUSTs.	Table 5-1, Table 5-2
(92)	Tank Monitoring identified an intrusion in tank TX-302-C when level trend analysis showed a sharp increase in the level readings following a severe rainstorm on May 13, 2015. Subsequent level increases were also shown to correlate with precipitation events.	Table 5-2
(93)	Based on tank level readings in SACS, it has been concluded by the Tank Monitoring Group, Tank and Pipeline Integrity Group and the Design Authority that CR-244-001 has an intrusion. The tank is 19.7' in diameter, has a height of 19' (228") with a calculated volume limit of 220.7" (RPP-CALC-24219, Table1). The current level in the tank is 40.39" which is roughly 4,800 gallons. The current level/volume of waste in the tank is 18.3% of the total calculated volume limit. The surface level in the tank is increasing, on average, 2.5" a year. Based on these calculations it will take an additional 72 years to reach the total calculated volume limit.	Table 5-2
(94)	See RPP-RPT-59272, <i>Fiscal Year 2016 Visual Inspection Report for Single-Shell Tanks</i> , for the bases for intrusion decision.	Table 4-5, Table 4-6
(95)	See RPP-RPT-60093, <i>Fiscal Year 2017 Visual Inspection Report for Single-Shell Tanks</i> , for the bases for intrusion decision.	Table 4-5
(96)	Visual inspections of the interior of catch tank 241-C-301 were performed on May 4 and May 11, 2018. The inspection included measurements of the current levels of solid and liquid in the tank. The results are summarized in a letter report, Interoffice Memorandum WRPS-1803745 "FY18 Visual Inspection of Tank 241-C-301" (Schofield 2018).	Table 5-1
(97)	See RPP-RPT-60565, <i>Fiscal Year 2018 Visual Inspection Report for Single-Shell Tanks</i> , for the bases for intrusion decision.	Table 4-5
(98)	Tank S-104 integrity status was changed from "assumed leaker" to "sound." per RPP-ASMT-62316, <i>Leak Assessment Report for Tank 241-S-104</i> .	Table 4-3
(99)	The bases for tank leak/release volumes in B farm are summarized in RPP-RPT-61279. Tank B-107 appears to have had a liner leak. Integrity assessments were recommended for other B farm tanks classified as assumed leakers.	Table 4-2
(100)	The bases for tank leak/release volumes in BX farm are summarized in RPP-RPT-61279. Integrity assessments were recommended for all the BX-Farm tanks classified as assumed leakers and BX-107, currently classified as sound.	Table 4-2

Table 6-1. Waste Tank Summary Report Endnotes (11 pages)

No.	Comment/Reference	Location
(101)	The bases for tank leak/release volumes in BY farm are summarized in RPP-RPT-61279. B-103 appears to have leaked. Integrity assessments were recommended for all other BY Farm tanks, both assumed leakers and sound.	Table 4-2
(102)	The bases for tank leak/release volumes in C farm are summarized in RPP-RPT-61279. Integrity assessments were conducted for tanks C-105, C-110 and C-111, and were recommended for C-101 and the C-200 tanks. C-105 was reclassified as an assumed leaker and C-110 and C-111 were reclassified as sound. An informal assessment conducted for C-101 concluded the tank may have leaked near the spare inlet, but the liner was sound within 55 inches from the tank bottom and the tank could be retrieved by sluicing. There was no indication of a tank leak during retrieval for any of the C Farm tanks.	Table 4-2, Table 4-3
(103)	The bases for tank leak/release volumes in S farm are summarized in RPP-RPT-61279. An integrity assessment was conducted for tank S-104 and concluded the tank should be reclassified as “sound”.	Table 4-3
(104)	The bases for tank leak/release volumes in T farm are summarized in RPP-RPT-61279. T-106 and T-111 were determined to have leaked. Integrity assessments were recommended for other T Farm tanks currently classified as assumed leakers. A leak assessment report was issued for tank T-109 (RPP-ASMT-63776, <i>Leak Assessment Report for Tank 241-T-109</i>) and the recommendation of the leak assessment was that the integrity designation of tank T-109 should be changed from “assumed leaker” to “sound”.	Table 4-2, Table 4-3
(105)	The bases for tank leak/release volumes in TX farm are summarized in RPP-RPT-61279. TX-107 and TX-114 appear to have leaked. Integrity assessments were recommended for other TX Farm tanks currently classified as assumed leakers and for Tanks TX-104 and TX-118 currently classified as sound.	Table 4-2, Table 4-3
(106)	The bases for tank leak/release volumes in U farm are summarized in RPP-RPT-61279. Tanks U-104, U-110 and U-112 appear to have leaked. An integrity assessment was recommended for tank U-101.	Table 4-2
(108)	The DIL volumes were updated (RPP-RPT-60305, <i>Single-Shell Tank Updated Drainable Interstitial Liquid Volumes – 2017</i>) beginning with HNF-EP-0182, Rev. 375 to provide a consistent method for calculating the volume of DIL for each tank. RPP-RPT-60305 will be periodically updated to reflect new information as the Best-basis Inventory reports are updated. The DIL volumes are based on recent tank interstitial liquid and surface level measurements, recent Best Basis Inventory waste volumes, consistent and referenceable waste drainable porosities and capillary heights, and a consistent method for estimating tank waste volumes from waste liquid or waste surface level values. HNF-EP-0182, Rev. 409 was updated to reflect changes to the DIL identified in RPP-RPT-60305, Rev. 3, <i>Single-Shell Tank Updated Drainable Interstitial Liquid Volumes – 2020</i> .	Table 4-1
(109)	Tanks 241-EW-151, 241-TX-302C and 241-UX-302A have known intrusions (Environmental Operational Activities Notification #TOC-ENV-NOT:2018-4520, Rev. 1, dated 11/5/2018). Intrusion into tanks A-302-A and A-350 was identified on 5/20/2019 (Environmental Notification Form # TOC-ENV-NOT-2019-4546). Notification of intrusion for tanks 241-A-417, 241-AZ-151, 241-U-301-B, 244-A Tank, 244-AR TK-003, 244-CR-001, 244-CR-003 and 244-TX Tank can be found in TOC-ENV-NOT:2019-4560. Notification for Intrusion Detected in 244-AR Cell 3 Sump can be found in TOC-ENV-NOT-2014-4032. Intrusion into tank 241-A-302B was identified on 10/27/2021 (Environmental Notification Form # TOC-ENV-NOT-2021-4627). Notification for Intrusion Detected in 241-TX-302B can be found in TOC-ENV-NOT-2025-4754.	Table 5-2

Table 6-1. Waste Tank Summary Report Endnotes (11 pages)

No.	Comment/Reference	Location
(110)	Tank AX-102 nominal waste volume – Total waste 2.9 kgal (RPP-RPT-44740, <i>Derivation of Best-Basis Inventory Report for Tank 241-AX-102 as of January 1, 2021</i>). Tank AX-102 retrieval operations using first and second retrieval technologies are considered complete (RPP-RPT-62066, <i>Single-Shell Tank 241-AX-102 Retrieval Completion Report</i>).	Table 2-1
(111)	See RPP-RPT-61200, <i>Fiscal Year 2019 Visual Inspection Report for Single-Shell Tanks</i> , for the bases for intrusion decision.	Table 4-5
(112)	See RPP-RPT-62005, <i>Fiscal Year 2020 Visual Inspection Report for Single-Shell Tanks</i> , for the bases for intrusion decision.	Table 4-5
(113)	Tank AX-104 nominal waste volume – It is estimated that the residual volume after retrieval is 5,145 gal (RPP-RPT-63243, <i>Laser Scanning Waste Volume Estimate for Tank 241-AX-104</i>). Tank AX-104 retrieval operations using first and second retrieval technologies are considered complete (RPP-RPT-63643, <i>Single-Shell Tank 241-AX-104 Retrieval Completion Report</i>).	Table 2-1
(114)	Tank TX-113 integrity status was changed from “assumed leaker” to “sound” per RPP-ASMT-64217, <i>Leak Assessment Report for Tank 241-TX-113</i> .	Table 4-3
(115)	On April 29, 2021, the WRPS Executive Safety Review Board (ESRB) recommended that the current integrity status for tank B-109 should be changed from “sound” to “assumed leaker” and added to the list of “assumed leaker” SSTs in this report. Tank B-109 integrity status was changed from “sound” to “assumed leaker” per RPP-ASMT-64349, <i>Leak Assessment Report for Tank 241-B-109</i> .	Table 4-2
(116)	See RPP-RPT-59854, Rev.4, <i>Derivation of Best-Basis Inventory for Tank 241-AX-103 as of April 1, 2023</i> , for tank inventory calculations. Table 2-2 of the BBI lists a Total estimate of 5,875 gallons.	Table 2-1
(117)	See RPP-TE-58839, <i>Water Intrusion into Single-Shell Tank S-102</i> , for basis of intrusion decision or Environmental Notification Form # TOC-ENV-NOT-2022-4649.	Table 4-5
(118)	Intrusion into tanks 241-C-201, see RPP-TE-58847, <i>Water Intrusion into Tank 241-C-201</i> , for basis of decision or Environmental Notification Form # TOC-ENV-NOT-2022-4650. Intrusion into tanks 241-C-202, see RPP-TE-58845, <i>Water Intrusion into Tank 241-C-202</i> , for basis of decision or Environmental Notification Form # TOC-ENV-NOT-2022-4650. Intrusion into tanks 241-C-203, see RPP-TE-58843, <i>Water Intrusion into Tank 241-C-203</i> , for basis of decision or Environmental Notification Form # TOC-ENV-NOT-2022-4650. Intrusion into tanks 241-C-204, see RPP-TE-58842, <i>Water Intrusion into Tank 241-C-204</i> , for basis of decision or Environmental Notification Form # TOC-ENV-NOT-2022-4650.	Table 4-5
(119)	See RPP-RPT-63731, <i>Estimated Leak Volume for Single-Shell Tank 241-B-109</i> , for leak volume.	Table 4-2
(120)	See, RPP-RPT-62815, Revision 0, <i>Fiscal Year 2021 Visual Inspection Report for Single-Shell Tanks</i> , for basis for intrusion decision.	Table 4-6
(121)	Estimated volume in tank 241-AX-101 at the end of June 2024 was 10,684 gallons following Batch 37 retrieval operations, based on a liquid displacement measurement performed on 6/11/2024 measuring 9,983 gallons (Champion Z, A. 06-03-2024, email and associated tracking spreadsheet) and a final flush totaling 701 gallons added on 6/12/2024. As of July 2, 2024, retrieval has halted and the tank is undergoing efforts to certify completion. No letter has been sent to ORP/Ecology indicating retrieval is complete.	Table 2-1
(122)	See, RPP-RPT-60565, Revision 0, <i>Fiscal Year 2018 Visual Inspection Report for Single-Shell Tanks</i> , and RPP-TE-58907, Revision 0, <i>Technical Evaluation of Tank 241-S-107 Waste Surface Level Trend</i> , for basis of intrusion decision.	Table 4-5

Table 6-1. Waste Tank Summary Report Endnotes (11 pages)

No.	Comment/Reference	Location
(123)	Tanks 241-TX-115 and 241-TX-116 were originally classified as Assumed Leakers, but assessments later returned their status to "Sound." The full report for the TX-115 Leak Assessment can be found in RPP-ASMT-65246, <i>Leak Assessment Report for Tank 241-TX-115</i> , and the notification to Ecology for the TX-116 Leak Assessment can be found in TOC-ENV-NOT-2023-4703. As of 10/31/2023, the official leak report for 241-TX-116 was still under review.	Table 4-3
(124)	Estimated volume in tank 241-A-101 at the end of November 2024 was approximately 153,164 gallons, based on Retrieval Engineering estimate of 152,427 gallons remaining in A-101 following Batch 18 of retrieval operations (Waymire, S. M., 11-06-2024), and an addition of 737 gallons of water used for post-retrieval flushing.	Table 2-1, Table 4-1
(125)	The status of tank 241-T-101 was changed from "Sound" to "Assumed Leaker" at the Executive Safety Review Board on August 15, 2024 (RPP-RPT-65071, Rev. 0, <i>2024 Leak Assessment Report for Tank 241-T-101</i>). RPP-CALC-66615, Rev. 0, <i>Estimated Leak Volume for Single-Shell Tank 241-T-101</i> estimates a leak of 2,410 gallons.	Table 4-1
(126)	See RPP-TE-59025, <i>Technical Evaluation of Potential Intrusion into Tank 241-TX-101</i> , for the basis of intrusion decision on Tank 241-TX-101.	Table 4-5
(127)	Estimated volume in tank 241-A-102 at the end of February 2025 was approximately 38,447 gallons, based on the Retrieval Engineering estimate of 37,446 gallons remaining in A-102 following Batch 1 of retrieval operations and an addition of 1,001 gallons of water user for post-retrieval flushing.	Table 2-1, Table 4-1
DOE	= U.S. Department of Energy	SST = single-shell tank
DST	= double-shell tank	TWINS = Tank Waste Information Network System
Ecology	= Washington State Department of Ecology	WAC = Washington Administrative Code
ORP	= U.S. Department of Energy, Office of River Protection	

6.2 REFERENCES

- 24950-WTP-ICD-MG-019, 2013, *ICD 19 – Interface Control Document for Waste Feed*, Rev. 6, Bechtel National, Inc., Richland, Washington.
- Baumhardt, R. J., 1989, “Single Shell Tank Leak Volumes,” (Letter 8901832B R1 to R. E. Gerton, U.S. Department of Energy, Richland Operations Office, May 15), Westinghouse Hanford Company, Richland, Washington.
- Brown, N.L., 2023, “RE: AX-101 Retrieval Progress Updates, 3-28-23,” (email to B. D. Hay), Washington River Protection Solutions LLC (WRPS) Tank Farms, Richland, Washington.
- Catlin, R. J., 1980, *Assessment of the Surveillance Program of the High-Level Waste Storage Tanks at Hanford*, Office of Environmental Compliance and Review, U.S. Department of Energy, Washington, D.C.
- Clark, W. C., 2012, “Contract Number DE AC27 08RV1480 – Washington River Protection Solutions, LLC Tank 241-AY-102 Primary Tank Leak Integrity Change from Sound to Assumed Leaker, and Double-Shell Waste Tank Leak Integrity Definitions,” (Letter WRPS-1204634 to T. W. Fletcher, U.S. Department of Energy, Office of River Protection, November 13), Washington River Protection Solutions, LLC, Richland, Washington.
- DOE O 435.1, 2001, *Radioactive Waste Management*, Change 1 (Certified 2007), U.S. Department of Energy, Washington, D.C.
- Dunning, A. B., 2010, “Contract Number DE AC27 08RV14800 – Washington River Protection Solutions LLC Completion of Performance Based Incentive 1.5, Fee Bearing Milestone 1.5.1, Remove Liquids from the Secondary Containment of the 244-CR Vault – Request for Incremental Fee Approval,” (Letter WRPS-1000848 to S. E. Bechtol, U.S. Department of Energy, Office of River Protection, April 28), Washington River Protection Solutions, LLC, Richland, Washington.
- Ecology, EPA, and DOE, 1989, *Hanford Federal Facility Agreement and Consent Order – Tri-Party Agreement (TPA)*, as amended, Washington State Department of Ecology, U.S. Environmental Protection Agency, and U.S. Department of Energy, Olympia, Washington.
- Fletcher, T. W., 2013a, “The U.S. Department of Energy, Office of River Protection (ORP) Submits the Retrieval Completion Certification and Report for Tank 241-C-104,” (Letter 13-TF-0018 to J. A. Hedges, Washington State Department of Ecology, March 21), U.S. Department of Energy, Office of River Protection, Richland, Washington.
- Fletcher, T. W., 2013b, “The U.S. Department of Energy, Office of River Protection (ORP) Submits the Retrieval Completion Certification and Report for Tank 241-C-108,” (Letter 13-TF-0025 to J. A. Hedges, Washington State Department of Ecology, May 1), U.S. Department of Energy, Office of River Protection, Richland, Washington.
- Groth, D. R., 1987, “Liquid Level Losses in Tanks 241-C-201, 202, and 204,” (Internal Memorandum 65950-87-517 to R. J. Baumhardt, July 1), Westinghouse Hanford Company, Richland, Washington.

HNF-EP-0182
Revision 447

- HNF-5985, 2000, *ER-311 Flammable Gas Response and Findings*, Rev. 0, CH2M HILL Hanford Group, Inc., Richland, Washington.
- HNF-EP-0182, 2005, *Waste Tank Summary Report for Month Ending September 30, 2005*, Rev. 210, CH2M HILL Hanford Group, Inc., Richland, Washington.
- HNF-SD-RE-TI-178, 2005, *Single Shell Tank Interim Stabilization Record*, Rev. 9, CH2M HILL Hanford Group, Inc., Richland, Washington.
- HNF-SD-WM-OCD-015, 2021, *Tank Farms Waste Transfer Compatibility Program*, Rev. 55, Washington River Protection Solutions, LLC, Richland, Washington.
- Jensen, L., and Merrill, J. A., 1989, "Estimation of Single Shell Tank Leak Volumes," (Internal Letter 12710-89-042 to R. E. Raymond, March 28), Westinghouse Hanford Company, Richland, Washington.
- Lyon, J. J., 2005, "Tank Farm Vadose Zone Contamination Volume Estimates, RPP-23405, Revision 1, released September 6, 2005; Waste Tank Summary Report for August and September 2005, HNF-EP-0182, Revisions 209 and 210," (Letter to R. J. Schepens, U.S. Department of Energy, Office of River Protection, December 22), Washington State Department of Ecology, Richland, Washington.
- Olinger, S. J., 2007a, "Submittal of Retrieval Data Report (RDR) for Single-Shell Tank 241-C-103, RPP-RPT-33060, Revision 0," (Letter 07-TPD-026 to J. Hedges, Washington State Department of Ecology, May 21), U.S. Department of Energy, Office of River Protection, Richland, Washington.
- Olinger, S. J., 2007b, "Submittal of Demonstration Retrieval Data Report (RDR) for Single-Shell Tank 241-C-204, RPP-RPT-34062, Revision 0," (Letter 07-TPD-043 to J. Hedges, Washington State Department of Ecology, August 9), U.S. Department of Energy, Office of River Protection, Richland, Washington.
- Olinger, S. J., 2007c, "Submittal of Retrieval Data Report (RDR) for Single-Shell Tank 241-S-112, RPP-RPT-35112, Revision 0," (Letter 07-TPD-066 to J. Hedges, Washington State Department of Ecology, December 21), U.S. Department of Energy, Office of River Protection, Richland, Washington.
- Olinger, S. J., 2007d, "Submittal of Notification of Completion of Liquid Removal from Catch Tank 241-ER-311," (Letter 07-TOD-026 to J. Hedges, Washington State Department of Ecology, March 30), U.S. Department of Energy, Office of River Protection, Richland, Washington.
- OSD-T-151-00007, 2023, *Operating Specifications for the Double-Shell Storage Tanks*, Rev. 33, Washington River Protection Solutions, LLC, Richland, Washington.
- OSD-T-151-00031, 2023, *Operating Specifications for Tank Farm Leak Detection and Single-Shell Tank Intrusion Detection*, Rev. 24, Washington River Protection Solutions, LLC, Richland, Washington.
- PNL-4688, 1983, *Assessment of Single-Shell Tank Residual Liquid Issues at Hanford Site*, Washington, Pacific Northwest Laboratory, Richland, Washington.
- RHO-CD-1273, 1981, *Criterion for Selection of 100 Series Tanks to be Jet Pumped*, Rockwell Hanford Operations, Richland, Washington.

- RHO-RE-SR-14, 1984, *Waste Status Summary*, Rockwell Hanford Operations, Richland, Washington.
- RP-CHG-TANKFARM-2001-0014, 2001, "Catch Tank 152-AX Was Identified as a Potential Leaking Tank," CH2M HILL Hanford Group, Inc., Richland, Washington.
- RP-CHG-TANKFARM-2002-0083, 2002, "Video Surveillance Reveals Catch Tank TA-R1 Floating Off of Its Foundation at 242-TA Vault," CH2M HILL Hanford Group, Inc., Richland, Washington.
- RPP-10006, 2021, *Methodology and Calculations for the Assignment of Waste Groups for the Large Underground Waste Storage Tanks at the Hanford Site*, Rev. 18, Washington River Protection Solutions, LLC, Richland, Washington.
- RPP-12051, 2003, *244-AR Vault Interim Stabilization Completion Report*, Rev. 0, CH2M HILL Hanford Group, Inc., Richland, Washington.
- RPP-13019, 2003, *Determination of Hanford Waste Tank Volumes*, Rev. 0, CH2M HILL Hanford Group, Inc., Richland, Washington.
- RPP-23405, 2005, *Tank Farm Vadose Zone Contamination Volume Estimates*, Rev. 1, CH2M HILL Hanford Group, Inc., Richland, Washington.
- RPP-29441, 2006, *Post-Retrieval Waste Volume Determination for Single Shell Tank 241-C-201*, Rev. 0, CH2M HILL Hanford Group, Inc., Richland, Washington.
- RPP-32681, 2013, *Process to Assess Tank Farm Leaks in Support of Retrieval and Closure Planning*, Rev. 2, Washington River Protection Solutions, LLC, Richland, Washington.
- RPP-ASMT-33741, 2007, *Tank 241-EW-151 Leak Assessment Report*, Rev. 0, CH2M HILL Hanford Group, Inc., Richland, Washington.
- RPP-ASMT-35057, 2007, *Tank 240-S-302 Leak Assessment Report*, Rev. 0, CH2M HILL Hanford Group, Inc., Richland, Washington.
- RPP-ASMT-38219, 2008, *Tank 241-C-110 Leak Assessment Report*, Rev. 0, CH2M HILL Hanford Group, Inc., Richland, Washington.
- RPP-ASMT-39155, 2008, *Tank 241-C-111 Leak Assessment Report*, Rev. 0, CH2M HILL Hanford Group, Inc., Richland, Washington.
- RPP-ASMT-42278, 2009, *Tank 241-A-103 Leak Assessment Report*, Rev. 0, Washington River Protection Solutions, LLC, Richland, Washington.
- RPP-ASMT-42628, 2014, *Tank 241-AX-102 Integrity Assessment Report*, Rev. 0, Washington River Protection Solutions, LLC, Richland, Washington.
- RPP-ASMT-46452, 2010, *Tank 241-C-105 Leak Assessment Report*, Rev. 0, Washington River Protection Solutions, LLC, Richland, Washington.
- RPP-ASMT-47140, 2010, *Tank 241-SX-110 Leak Assessment Report*, Rev. 0, Washington River Protection Solutions, LLC, Richland, Washington.
- RPP-ASMT-48143, 2011, *Tank 241-SX-104 Leak Assessment Completion Report*, Rev. 0, Washington River Protection Solutions, LLC, Richland, Washington.

- RPP-ASMT-53793, 2012, *Tank 241-AY-102 Leak Assessment Report*, Rev. 0, Washington River Protection Solutions, LLC, Richland, Washington.
- RPP-ASMT-57574, 2014, *Tank 241-AX-104 Integrity Assessment Report*, Rev. 0, Washington River Protection Solutions, LLC, Richland, Washington.
- RPP-ASMT-62316, 2018, *Leak Assessment Report for Tank 241-S-104*, Rev. 0, Washington River Protection Solutions, LLC, Richland, Washington.
- RPP-ASMT-62935, 2019, *Leak Assessment Report for Tank 241-T-101*, Rev. 0, Washington River Protection Solutions, LLC, Richland, Washington.
- RPP-ASMT-63062, 2020, *Leak Assessment Report for Tank 241-SX-104 Interstitial Liquid Level Anomaly 2017*, Rev. 0, Washington River Protection Solutions, LLC, Richland, Washington.
- RPP-ASMT-63776, 2020, *Leak Assessment Report for Tank 241-T-109*, Rev. 0, Washington River Protection Solutions, LLC, Richland, Washington.
- RPP-ASMT-64217, 2021, *Leak Assessment Report for Tank 241-TX-113*, Rev. 0, Washington River Protection Solutions, LLC, Richland, Washington.
- RPP-ASMT-64349, 2021, *Leak Assessment Report for Tank 241-B-109*, Rev. 0, Washington River Protection Solutions, LLC, Richland, Washington.
- RPP-ASMT-65246, 2022, *Leak Assessment Report for Tank 241-TX-115*, Rev. 0, Washington River Protection Solutions, LLC, Richland, Washington.
- RPP-CALC-24219, 2005, *244 CR Vault Tank and Cell Volume Calculations*, Rev. 0, CH2M HILL Hanford Group, Inc., Richland, Washington.
- RPP-CALC-33163, 2007, *Tank Waste Volume and Level Calculations in Dome Space for 241-AP Tank Farm Up to 460 Inches*, Rev. 0, CH2M HILL Hanford Group, Inc., Richland, Washington.
- RPP-CALC-52903, 2014, *Retrieval Performance of Tank 241-C-107 Using the Bulk Mobile Arm Retrieval System*, Rev. 3, Washington River Protection Solutions, LLC, Richland, Washington.
- RPP-CALC-54266, 2013, *Post-Hard Heel Retrieval Camera/CAD Modeling System Waste Volume Estimate for Tank 241-C-108*, Rev. 0, Washington River Protection Solutions, LLC, Richland, Washington.
- RPP-CALC-54284, 2013, *Post-Hard Heel Retrieval Camera/CAD Modeling System Waste Volume Estimate for Tank 241-C-104*, Rev. 0, Washington River Protection Solutions, LLC, Richland, Washington.
- RPP-CALC-54759, 2013, *Post-Hard Heel Retrieval Camera/CAD Modeling System Waste Volume Estimate for Tank 241-C-019*, Rev. 0, Washington River Protection Solutions, LLC, Richland, Washington.
- RPP-CALC-56399, 2013, *Post-Hard Heel Retrieval Camera/CAD Modeling System Waste Volume Estimate for Tank 241-C-110*, Rev. 0, Washington River Protection Solutions, LLC, Richland, Washington.

- RPP-CALC-56434, 2013, *Post-Retrieval Camera/CAD Modeling System Waste Volume Estimate for Tank 241-C-101*, Rev. 0, Washington River Protection Solutions, LLC, Richland, Washington.
- RPP-CALC-56856, 2014, *Estimated Waste Volume Remaining in Single-Shell Tank 241-C-112 after Hard Heel Retrieval*, Rev. 0, Washington River Protection Solutions, LLC, Richland, Washington.
- RPP-CALC-60933, 2016, *Residual Waste Volume of Tank 241-C-105 Following Operations of MARS-V System*, Rev. 0, Washington River Protection Solutions, LLC, Richland, Washington.
- RPP-CALC-61081, 2017, *241-AY-102 Waste Retrieval Tracking*, Rev. 1, Washington River Protection Solutions, LLC, Richland, Washington.
- RPP-CALC-62497, 2020, *Tank Side Cesium Removal (TSCR) IXC-150 Sizing*, Rev. 2, AVANTech, Inc., Richland, Washington.
- RPP-CALC-64587, 2021, *Tank 241-AX-104 Retrieval Volume Tracking Information*, Rev. 00A, Washington River Protection Solutions, LLC, Richland, Washington.
- RPP-CALC-66615, 2024, *Estimated Leak Volume for Single-Shell Tank 242-T-101*, Rev. 0, Washington River Protection Solutions, LLC, Richland, Washington.
- RPP-PLAN-59931, 2014, *AY-102 Recovery Project Waste Retrieval Work Plan*, Rev. 2, Washington River Protection Solutions, LLC, Richland, Washington.
- RPP-RPT-24257, 2005, *244-CR Vault Liquid Level Assessment and Video Inspection Completion Report*, Rev. 0, CH2M HILL Hanford Group, Inc., Richland, Washington.
- RPP-RPT-26475, 2008, *Retrieval Data Report for Single Shell Tank 241-C-203*, Rev. 1A, CH2M HILL Hanford Group, Inc., Richland, Washington.
- RPP-RPT-29095, 2006, *Retrieval Data Report for Single Shell Tank 241-C-202*, Rev. 0, CH2M HILL Hanford Group, Inc., Richland, Washington.
- RPP-RPT-29163, 2006, *Tank 241-ER-311 Leak Assessment Report*, Rev. 0, CH2M HILL Hanford Group, Inc., Richland, Washington.
- RPP-RPT-29711, 2006, *Tank 241-UX-302A Leak Assessment Report*, Rev. 0, CH2M HILL Hanford Group, Inc., Richland, Washington.
- RPP-RPT-31779, 2006, *241-UX-302A Catch Tank Liquid Mitigation Completion Report*, Rev. 0, CH2M HILL Hanford Group, Inc., Richland, Washington.
- RPP-RPT-33060, 2007, *Retrieval Data Report for Single Shell Tank 241-C-103*, Rev. 0, CH2M HILL Hanford Group, Inc., Richland, Washington.
- RPP-RPT-34062, 2007, *Retrieval Data Report for Single Shell Tank 241-C-204*, Rev. 0, CH2M HILL Hanford Group, Inc., Richland, Washington.
- RPP-RPT-35112, 2007, *Retrieval Data Report for Single Shell Tank 241-S-112*, Rev. 0, CH2M HILL Hanford Group, Inc., Richland, Washington.
- RPP-RPT-42296, 2010, *Hanford TY-Farm Leak Assessments Report*, Rev. 0, Washington River Protection Solutions, LLC, Richland, Washington.

- RPP-RPT-42789, 2009, *Completion of Removal of Pumpable Liquid From 241-UX-302A*, Rev. 0, Washington River Protection Solutions, LLC, Richland, Washington.
- RPP-RPT-43493, 2025 *Derivation of Best-Basis Inventory for Tank 241-AP-106 as of January 1, 2025*, Rev. 22, Hanford Tank Waste Operations & Closure, LLC, Richland, Washington.
- RPP-RPT-43498, 2024, *Derivation of Best-Basis Inventory for Tank 241-AP-105 as of August 1, 2024*, Rev. 6, Washington River Protection Solutions, LLC, Richland, Washington.
- RPP-RPT-43979, 2024, *Derivation of Best-Basis Inventory for Tank 241-AY-101 as of April 1, 2024*, Rev. 23, Washington River Protection Solutions, LLC, Richland, Washington.
- RPP-RPT-43992, 2021, *Derivation of Best-Basis Inventory for Tank 241-AN-106 as of October 1, 2021*, Rev. 24, Washington River Protection Solutions, LLC, Richland, Washington.
- RPP-RPT-44049, 2024, *Derivation of Best-Basis Inventory for Tank 241-AZ-102 as of July 1, 2024*, Rev. 27, Washington River Protection Solutions, LLC, Richland, Washington.
- RPP-RPT-44625, 2024, *Derivation of Best-Basis Inventory for Tank 241-AW-105 as of November 1, 2024*, Rev. 9, Washington River Protection Solutions, LLC, Richland, Washington.
- RPP-RPT-44630, 2023, *Derivation of Best-Basis Inventory for Tank 241-AY-102 as of January 1, 2023*, Rev. 17, Washington River Protection Solutions, LLC, Richland, Washington.
- RPP-RPT-44637, 2023, *Derivation of Best-Basis Inventory for Tank 241-AZ-101 as of July 13, 2023*, Rev. 20, Washington River Protection Solutions, LLC, Richland, Washington.
- RPP-RPT-44643, 2024, *Derivation of Best-Basis Inventory for Tank 241-SY-102 as of December 1, 2024*, Rev. 12, Washington River Protection Solutions, LLC, Richland, Washington.
- RPP-RPT-44740, 2021, *Derivation of Best-Basis Inventory Report for Tank 241-AX-102 as of January 1, 2021*, Rev. 7, Washington River Protection Solutions, LLC, Richland, Washington.
- RPP-RPT-44752, 2022, *Derivation of Best-Basis Inventory for Tank 241-BY-103 as of January 1, 2022*, Rev. 5, Washington River Protection Solutions, LLC, Richland, Washington.
- RPP-RPT-44814, 2022, *Derivation of Best-Basis Inventory for Tank 241-AN-101 as of July 1, 2022*, Rev. 31, Washington River Protection Solutions, LLC, Richland, Washington.
- RPP-RPT-45147, 2023, *Derivation of Best-Basis Inventory for Tank 241-C-108 as of July 1, 2023*, Rev. 7, Washington River Protection Solutions, LLC, Richland, Washington.
- RPP-RPT-45764, 2023, *Derivation of Best-Basis Inventory for Tank 241-AN-102 as of July 1, 2023*, Rev. 9, Washington River Protection Solutions, LLC, Richland, Washington.
- RPP-RPT-45845, 2010, *Completion of Pumpable Liquids Removal from 244-CR Vault*, Rev. 0, Washington River Protection Solutions, LLC, Richland, Washington.
- RPP-RPT-46616, 2023, *Derivation of Best-Basis Inventory for Tank 241-C-104 as of July 1, 2023*, Rev. 10, Washington River Protection Solutions, LLC, Richland, Washington.
- RPP-RPT-46686, 2018, *Derivation of Best-Basis Inventory for Tank 241-AW-106 as of July 1, 2018*, Rev. 10, Washington River Protection Solutions, LLC, Richland, Washington.

HNF-EP-0182
Revision 447

- RPP-RPT-46772, 2023, *Derivation of Best-Basis Inventory for Tank 241-AN-107 as of May 1, 2023*, Rev. 7, Washington River Protection Solutions, LLC, Richland, Washington.
- RPP-RPT-46792, 2025, *Derivation of Best-Basis Inventory for Tank 241-AW-102 as of January 1, 2025*, Rev. 23, Washington River Protection Solutions, LLC, Richland, Washington.
- RPP-RPT-47139, 2025, *Derivation of Best-Basis Inventory for Tank 241-T-112 as of January 1, 2025*, Rev. 3, Hanford Tank Waste Operations & Closure, LLC, Richland, Washington.
- RPP-RPT-48025, 2022, *Derivation of Best-Basis Inventory for Tank 241-S-102 as of May 1, 2022*, Rev. 3, Washington River Protection Solutions, LLC, Richland, Washington.
- RPP-RPT-48103, 2025, *Derivation of Best-Basis Inventory for Tank 241-AP-107 as of January 1, 2025*, Rev. 22, Hanford Tank Waste Operations & Closure, LLC, Richland, Washington.
- RPP-RPT-48459, 2023, *Derivation of Best-Basis Inventory for Tank 241-C-111 as of October 1, 2023*, Rev. 5, Washington River Protection Solutions, LLC, Richland, Washington.
- RPP-RPT-48639, 2025, *Derivation of Best-Basis Inventory for Tank 241-AP-104 as of January 1, 2025*, Rev. 23, Hanford Tank Waste Operations & Closure, LLC, Richland, Washington.
- RPP-RPT-48745, 2023, *Derivation of Best-Basis Inventory for Tank 241-C-107 as of July 1, 2023*, Rev. 11, Washington River Protection Solutions, LLC, Richland, Washington.
- RPP-RPT-48774, 2024, *Derivation of Best-Basis Inventory for Tank 241-SY-101 as of July 1, 2024*, Rev. 5, Washington River Protection Solutions, LLC, Richland, Washington.
- RPP-RPT-49535, 2018, *Derivation of Best-Basis Inventory for Tank 241-TX-117 as of January 1, 2018*, Rev. 1, Washington River Protection Solutions, LLC, Richland, Washington.
- RPP-RPT-49876, 2024, *Derivation of Best-Basis Inventory for Tank 241-C-110 as of October 1, 2024*, Rev. 5, Washington River Protection Solutions, LLC, Richland, Washington.
- RPP-RPT-50313, 2025, *Derivation of Best-Basis Inventory for Tank 241-AP-101 as of February 1, 2025*, Rev. 7, Hanford Tank Waste Operations & Closure, LLC, Richland, Washington.
- RPP-RPT-50799, 2015, *Suspect Water Intrusion in Single-Shell Tanks*, Rev. 2, Washington River Protection Solutions, LLC, Richland, Washington.
- RPP-RPT-51224, 2025, *Derivation of Best-Basis Inventory for Tank 241-TX-101 as of January 1, 2025*, Rev. 3, Washington River Protection Solutions, LLC, Richland, Washington.
- RPP-RPT-51225, 2023, *Derivation of Best-Basis Inventory for Tank 241-TX-105 as of February 1, 2023*, Rev. 3, Washington River Protection Solutions, LLC, Richland, Washington.
- RPP-RPT-51226, 2019, *Derivation of Best-Basis Inventory for Tank 241-TX-109 as of August 1, 2019*, Rev. 2, Washington River Protection Solutions, LLC, Richland, Washington.
- RPP-RPT-51343, 2023, *Derivation of Best-Basis Inventory for Tank 241-C-109 as of July 1, 2023*, Rev. 7, Washington River Protection Solutions, LLC, Richland, Washington.
- RPP-RPT-52174, 2024, *Derivation of Best-Basis Inventory for Tank 241-BY-111 as of January 1, 2024*, Rev. 2, Washington River Protection Solutions, LLC, Richland, Washington.
- RPP-RPT-52180, 2020, *Derivation of Best-Basis Inventory for Tank 241-SX-106 as of January 1, 2020*, Rev. 3, Washington River Protection Solutions, LLC, Richland, Washington.

HNF-EP-0182
Revision 447

- RPP-RPT-52516, 2023, *Derivation of Best-Basis Inventory for Tank 241-C-112 as of October 1, 2023*, Rev. 4, Washington River Protection Solutions, LLC, Richland, Washington.
- RPP-RPT-54017, 2023, *Derivation of Best-Basis Inventory for Tank 241-AP-102 as of October 1, 2023*, Rev. 16, Washington River Protection Solutions, LLC, Richland, Washington.
- RPP-RPT-54440, 2023, *Derivation of Best-Basis Inventory for Tank 241-C-101 as of October 1, 2023*, Rev. 5, Washington River Protection Solutions, LLC, Richland, Washington.
- RPP-RPT-54964, 2014, *Evaluation of Tank 241-T-111 Level Data and In Tank Video Inspection*, Rev. 2, Washington River Protection Solutions, LLC, Richland, Washington.
- RPP-RPT-55192, 2022, *Derivation of Best-Basis Inventory for Tank 241-AW-103 as of January 1, 2022*, Rev. 5, Washington River Protection Solutions, LLC, Richland, Washington.
- RPP-RPT-56803, 2023, *Derivation of Best-Basis Inventory for Tank 241-BX-103 as of January 1, 2023*, Rev. 4, Washington River Protection Solutions, LLC, Richland, Washington.
- RPP-RPT-56866, 2020, *Derivation of Best-Basis Inventory for Tank 241-A-103 as of October 1, 2020*, Rev. 3, Washington River Protection Solutions, LLC, Richland, Washington.
- RPP-RPT-57019, 2024, *Derivation of Best-Basis Inventory for Tank 241-BY-101 as of April 1, 2024*, Rev. 4, Washington River Protection Solutions, LLC, Richland, Washington.
- RPP-RPT-57068, 2024, *Derivation of Best-Basis Inventory for Tank 241-B-203 as of October 1, 2024*, Rev. 3, Washington River Protection Solutions, LLC, Richland, Washington.
- RPP-RPT-57069, 2024, *Derivation of Best-Basis Inventory for Tank 241-B-204 as of October 1, 2024*, Rev. 3, Washington River Protection Solutions, LLC, Richland, Washington.
- RPP-RPT-57089, 2025, *Derivation of Best-Basis Inventory for Tank 241-T-204 as of January 1, 2025*, Rev. 2, Washington River Protection Solutions, LLC, Richland, Washington.
- RPP-RPT-57097, 2025, *Derivation of Best-Basis Inventory for Tank 241-T-203 as of January 1, 2025*, Rev. 2, Washington River Protection Solutions, LLC, Richland, Washington.
- RPP-RPT-57338, 2022, *Derivation of Best-Basis Inventory for Tank 241-U-111 as of October 1, 2022*, Rev. 3, Washington River Protection Solutions, LLC, Richland, Washington.
- RPP-RPT-57458, 2023, *Derivation of Best-Basis Inventory for Tank 241-C-102 as of January 1, 2023*, Rev. 7, Washington River Protection Solutions, LLC, Richland, Washington.
- RPP-RPT-58071, 2023, *Derivation of Best-Basis Inventory for Tank 241-C-105 as of July 1, 2023*, Rev.98, Washington River Protection Solutions, LLC, Richland, Washington.
- RPP-RPT-58156, 2014, *Basis for Miscellaneous Underground Storage Tanks and Special Surveillance Facilities Waste Volumes Published in HNF-EP-0182 Revision 320 "Waste Tank Summary Report for Month Ending August 31, 2014,"* Rev. 0, Washington River Protection Solutions, LLC, Richland, Washington.
- RPP-RPT-58176, 2024, *Derivation of Best-Basis Inventory for Tank 241-TY-102 as of April 1, 2024*, Rev. 2, Washington River Protection Solutions, LLC, Richland, Washington.
- RPP-RPT-58186, 2025, *Derivation of Best-Basis Inventory for Tank 241-T-101 as of January 1, 2025*, Rev. 4, Washington River Protection Solutions, LLC, Richland, Washington.

HNF-EP-0182
Revision 447

- RPP-RPT-58236, 2024, *Derivation of Best-Basis Inventory for Tank 241-S-111 as of February 1, 2024*, Rev. 2, Washington River Protection Solutions, LLC, Richland, Washington.
- RPP-RPT-58260, 2023, *Derivation of Best-Basis Inventory for Tank 241-BX-110 as of March 1, 2023*, Rev. 2, Washington River Protection Solutions, LLC, Richland, Washington.
- RPP-RPT-58270, 2024, *Derivation of Best-Basis Inventory for Tank 241-BX-101 as of April 1, 2024*, Rev. 3, Washington River Protection Solutions, LLC, Richland, Washington.
- RPP-RPT-58279, 2024, *Derivation of Best-Basis Inventory for Tank 241-BY-102 as of April 1, 2024*, Rev. 3, Washington River Protection Solutions, LLC, Richland, Washington.
- RPP-RPT-58447, 2025, *Derivation of Best-Basis Inventory for Tank 241-A-102 as of February 1, 2025*, Rev. 2, Hanford Tank Waste Operations & Closure, LLC, Richland, Washington.
- RPP-RPT-58456, 2024, *Derivation of Best-Basis Inventory for Tank 241-AP-103 as of October 1, 2024*, Rev. 10, Washington River Protection Solutions, LLC, Richland, Washington.
- RPP-RPT-58534, 2021, *Derivation of Best-Basis Inventory for Tank 241-B-109 as of September 1, 2021*, Rev. 2, Washington River Protection Solutions, LLC, Richland, Washington.
- RPP-RPT-58392, 2025, *Derivation of Best-Basis Inventory for Tank 241-T-201 as of January 1, 2025*, Rev. 3, Washington River Protection Solutions, LLC, Richland, Washington.
- RPP-RPT-58547, 2024, *Derivation of Best-Basis Inventory for Tank 241-T-111 as of April 1, 2024*, Rev. 3, Washington River Protection Solutions, LLC, Richland, Washington.
- RPP-RPT-58618, 2019, *Derivation of Best-Basis Inventory for Tank 241-T-110 as of October 1, 2019*, Rev. 2, Washington River Protection Solutions, LLC, Richland, Washington.
- RPP-RPT-58619, 2024, *Derivation of Best-Basis Inventory for Tank 241-B-202 as of October 1, 2024*, Rev. 2, Washington River Protection Solutions, LLC, Richland, Washington.
- RPP-RPT-58620, 2025, *Derivation of Best-Basis Inventory for Tank 241-AX-101 as of January 1, 2025*, Rev. 9, Washington River Protection Solutions, LLC, Richland, Washington.
- RPP-RPT-58655, 2024, *Derivation of Best-Basis Inventory for Tank 241-BX-111 as of April 1, 2024*, Rev. 4, Washington River Protection Solutions, LLC, Richland, Washington.
- RPP-RPT-58664, 2021, *Derivation of Best-Basis Inventory for Tank 241-SX-102 as of January 1, 2021*, Rev. 1, Washington River Protection Solutions, LLC, Richland, Washington.
- RPP-RPT-58671, 2024, *Derivation of Best-Basis Inventory for Tank 241-AW-104 as of July 1, 2024*, Rev. 3, Washington River Protection Solutions, LLC, Richland, Washington.
- RPP-RPT-58695, 2024, *Derivation of Best-Basis Inventory for Tank 241-TX-102 as of January 1, 2024*, Rev. 1, Washington River Protection Solutions, LLC, Richland, Washington.
- RPP-RPT-58696, 2020, *Derivation of Best-Basis Inventory for Tank 241-TX-103 as of April 1, 2020*, Rev. 1, Washington River Protection Solutions, LLC, Richland, Washington.
- RPP-RPT-58697, 2023, *Derivation of Best-Basis Inventory for Tank 241-TX-106 as of April 1, 2023*, Rev. 2, Washington River Protection Solutions, LLC, Richland, Washington.
- RPP-RPT-58698, 2023, *Derivation of Best-Basis Inventory for Tank 241-TX-107 as of January 1, 2023*, Rev. 2, Washington River Protection Solutions, LLC, Richland, Washington.

HNF-EP-0182
Revision 447

- RPP-RPT-58699, 2020, *Derivation of Best-Basis Inventory for Tank 241-TX-108 as of November 1, 2020*, Rev. 3, Washington River Protection Solutions, LLC, Richland, Washington.
- RPP-RPT-58700, 2015, *Derivation of Best-Basis Inventory for Tank 241-TX-110 as of April 1, 2023*, Rev. 1, Washington River Protection Solutions, LLC, Richland, Washington.
- RPP-RPT-58701, 2020, *Derivation of Best-Basis Inventory for Tank 241-TX-111 as of July 1, 2020*, Rev. 1, Washington River Protection Solutions, LLC, Richland, Washington.
- RPP-RPT-58726, 2015, *Derivation of Best-Basis Inventory for Tank 241-TX-112 as of October 1, 2015*, Rev. 0, Washington River Protection Solutions, LLC, Richland, Washington.
- RPP-RPT-58727, 2020, *Derivation of Best-Basis Inventory for Tank 241-TX-114 as of October 1, 2020*, Rev. 1, Washington River Protection Solutions, LLC, Richland, Washington.
- RPP-RPT-58728, 2023, *Derivation of Best-Basis Inventory for Tank 241-TX-115 as of January 1, 2023*, Rev. 1, Washington River Protection Solutions, LLC, Richland, Washington.
- RPP-RPT-58764, 2022, *Derivation of Best-Basis Inventory for Tank 241-SX-107 as of July 1, 2022*, Rev. 1, Washington River Protection Solutions, LLC, Richland, Washington.
- RPP-RPT-58765, 2024, *Derivation of Best-Basis Inventory for Tank 241-SX-109 as of January 1, 2024*, Rev. 1, Washington River Protection Solutions, LLC, Richland, Washington.
- RPP-RPT-58766, 2023, *Derivation of Best-Basis Inventory for Tank 241-SX-110 as of October 1, 2023*, Rev. 1, Washington River Protection Solutions, LLC, Richland, Washington.
- RPP-RPT-58767, 2023, *Derivation of Best-Basis Inventory for Tank 241-SX-111 as of October 1, 2023*, Rev. 1, Washington River Protection Solutions, LLC, Richland, Washington.
- RPP-RPT-58768, 2024, *Derivation of Best-Basis Inventory for Tank 241-SX-112 as of April 1, 2024*, Rev. 2, Washington River Protection Solutions, LLC, Richland, Washington.
- RPP-RPT-58769, 2023, *Derivation of Best-Basis Inventory for Tank 241-SX-113 as of October 1, 2023*, Rev. 2, Washington River Protection Solutions, LLC, Richland, Washington.
- RPP-RPT-58770, 2023, *Derivation of Best-Basis Inventory for Tank 241-SX-114 as of October 1, 2023*, Rev. 1, Washington River Protection Solutions, LLC, Richland, Washington.
- RPP-RPT-58771, 2024, *Derivation of Best-Basis Inventory for Tank 241-SX-115 as of January 1, 2024*, Rev.2, Washington River Protection Solutions, LLC, Richland, Washington.
- RPP-RPT-58788, 2015, *Retrieval Completion Certification Report for Tank C-102*, Rev. 0, Washington River Protection Solutions, LLC, Richland, Washington.
- RPP-RPT-58849, 2015, *Fiscal Year 2015 Visual Inspection Report for Single-Shell Tanks*, Rev. 0, Washington River Protection Solutions, LLC, Richland, Washington.
- RPP-RPT-58857, 2022, *Derivation of Best-Basis Inventory for Tank 241-A-104 as of July 1, 2022*, Rev. 4, Washington River Protection Solutions, LLC, Richland, Washington.
- RPP-RPT-58864, 2020, *Derivation of Best-Basis Inventory for Tank 241-A-105 as of April 1, 2020*, Rev. 3, Washington River Protection Solutions, LLC, Richland, Washington.
- RPP-RPT-58928, 2024, *Derivation of Best-Basis Inventory for Tank 241-T-103 as of October 1, 2024*, Rev. 1, Washington River Protection Solutions, LLC, Richland, Washington.

HNF-EP-0182
Revision 447

- RPP-RPT-58929, 2022, *Derivation of Best-Basis Inventory for Tank 241-C-201 as of May 1, 2022*, Rev. 1, Washington River Protection Solutions, LLC, Richland, Washington.
- RPP-RPT-58937, 2021, *Derivation of Best-Basis Inventory for Tank 241-S-108 as of April 1, 2021*, Rev. 1, Washington River Protection Solutions, LLC, Richland, Washington.
- RPP-RPT-59004, 2015, *Post Retrieval Camera. CAD Modeling System Waste Volume Estimate for Tank 241-C-102*, Rev. 0, Washington River Protection Solutions, LLC, Richland, Washington.
- RPP-RPT-59031, 2024, *Derivation of Best-Basis Inventory for Tank 241-B-101 as of October 1, 2024*, Rev. 2, Washington River Protection Solutions, LLC, Richland, Washington.
- RPP-RPT-59032, 2022, *Derivation of Best-Basis Inventory for Tank 241-B-102 as of April 1, 2022*, Rev. 1, Washington River Protection Solutions, LLC, Richland, Washington.
- RPP-RPT-59033, 2023, *Derivation of Best-Basis Inventory for Tank 241-B-103 as of January 1, 2023*, Rev. 2, Washington River Protection Solutions, LLC, Richland, Washington.
- RPP-RPT-59034, 2025, *Derivation of Best-Basis Inventory for Tank 241-B-104 as of January 1, 2025*, Rev. 2, Hanford Tank Waste Operations & Closure, LLC, Richland, Washington.
- RPP-RPT-59035, 2023, *Derivation of Best-Basis Inventory for Tank 241-B-105 as of July 1, 2023*, Rev. 1, Washington River Protection Solutions, LLC, Richland, Washington.
- RPP-RPT-59036, 2020, *Derivation of Best-Basis Inventory for Tank 241-B-110 as of February 1, 2020*, Rev. 1, Washington River Protection Solutions, LLC, Richland, Washington.
- RPP-RPT-59037, 2022, *Derivation of Best-Basis Inventory for Tank 241-B-112 as of February 1, 2022*, Rev. 2, Washington River Protection Solutions, LLC, Richland, Washington.
- RPP-RPT-59039, 2022, *Derivation of Best-Basis Inventory for Tank 241-AX-104 as of April 1, 2022*, Rev. 5, Washington River Protection Solutions, LLC, Richland, Washington.
- RPP-RPT-59272, 2017, *Fiscal Year 2016 Visual Inspection Report for Single-Shell Tanks*, Rev. 0, Washington River Protection Solutions, LLC, Richland, Washington.
- RPP-RPT-59283, 2024, *Derivation of Best-Basis Inventory for Tank 241-A-106 as of September 1, 2024*, Rev. 1, Washington River Protection Solutions, LLC, Richland, Washington.
- RPP-RPT-59824, 2019, *Derivation of Best-Basis Inventory for Tank 241-T-107 as of January 1, 2019*, Rev. 1, Washington River Protection Solutions, LLC, Richland, Washington.
- RPP-RPT-59356, 2019, *Derivation of Best-Basis Inventory for Tank 241-BX-102 as of August 1, 2019*, Rev. 2, Washington River Protection Solutions, LLC, Richland, Washington.
- RPP-RPT-59377, 2016, *Post-Retrieval Camera/CAD Modeling System Waste Volume Estimate for Tank 241-C-111*, Rev. 00, Washington River Protection Solutions, LLC, Richland, Washington.
- RPP-RPT-59386, 2024, *Derivation of Best-Basis Inventory for Tank 241-T-106 as of November 1, 2024*, Rev. 1, Washington River Protection Solutions, LLC, Richland, Washington.
- RPP-RPT-59403, 2025, *Derivation of Best-Basis Inventory for Tank 241-T-202 as of January 1, 2025*, Rev. 2, Hanford Tank Waste Operations & Closure, LLC, Richland, Washington.

HNF-EP-0182
Revision 447

- RPP-RPT-59407, 2023, *Derivation of Best-Basis Inventory for Tank 241-TY-101 as of January 1, 2023*, Rev. 2, Washington River Protection Solutions, LLC, Richland, Washington.
- RPP-RPT-59461, 2021, *Derivation of Best-Basis Inventory for Tank 241-T-102 as of April 1, 2021*, Rev. 1, Washington River Protection Solutions, LLC, Richland, Washington.
- RPP-RPT-59473, 2024, *Derivation of Best-Basis Inventory for Tank 241-T-104 as of October 1, 2024*, Rev. 1, Washington River Protection Solutions, LLC, Richland, Washington.
- RPP-RPT-59491, 2022, *Derivation of Best-Basis Inventory for Tank 241-U-201 as of October 1, 2022*, Rev. 1, Washington River Protection Solutions, LLC, Richland, Washington.
- RPP-RPT-59510, 2025, *Derivation of Best-Basis Inventory for Tank 241-B-201 as of January 1, 2025*, Rev. 3, Hanford Tank Waste Operations & Closure, LLC, Richland, Washington.
- RPP-RPT-59519, 2025, *Derivation of Best-Basis Inventory for Tank 241-T-105 as of January 1, 2025*, Rev. 2, Hanford Tank Waste Operations & Closure, LLC, Richland, Washington.
- RPP-RPT-59532, 2020, *Derivation of Best-Basis Inventory for Tank 241-T-109 as of August 1, 2020*, Rev. 2, Washington River Protection Solutions, LLC, Richland, Washington.
- RPP-RPT-59536, 2021, *Derivation of Best-Basis Inventory for Tank 241-TY-103 as of February 1, 2021*, Rev. 1, Washington River Protection Solutions, LLC, Richland, Washington.
- RPP-RPT-59537, 2022, *Derivation of Best-Basis Inventory for Tank 241-TY-104 as of January 1, 2022*, Rev. 2, Washington River Protection Solutions, LLC, Richland, Washington.
- RPP-RPT-59538, 2018, *Derivation of Best-Basis Inventory for Tank 241-TY-105 as of November 1, 2018*, Rev. 1, Washington River Protection Solutions, LLC, Richland, Washington.
- RPP-RPT-59562, 2020, *Derivation of Best-Basis Inventory for Tank 241-BY-105 as of July 1, 2020*, Rev. 1, Washington River Protection Solutions, LLC, Richland, Washington.
- RPP-RPT-59554, 2022, *Derivation of Best-Basis Inventory for Tank 241-U-202 as of October 1, 2022*, Rev. 1, Washington River Protection Solutions, LLC, Richland, Washington.
- RPP-RPT-59556, 2016, *Tank 241-AY-102 Monthly Monitoring Report June 2016*, Rev. 0, Washington River Protection Solutions, LLC, Richland, Washington.
- RPP-RPT-59559, 2024, *Derivation of Best-Basis Inventory for Tank 241-T-108 as of April 1, 2024*, Rev. 1, Washington River Protection Solutions, LLC, Richland, Washington.
- RPP-RPT-59572, 2022, *Derivation of Best-Basis Inventory for Tank 241-U-203 as of October 1, 2022*, Rev. 1, Washington River Protection Solutions, LLC, Richland, Washington.
- RPP-RPT-59601, 2016, *Tank 241-AY-102 Monthly Monitoring Report July 2016*, Rev. 0, Washington River Protection Solutions, LLC, Richland, Washington.
- RPP-RPT-59612, 2021, *Derivation of Best-Basis Inventory for Tank 241-U-101 as of May 1, 2021*, Rev. 2, Washington River Protection Solutions, LLC, Richland, Washington.
- RPP-RPT-59619, 2016, *Derivation of Best-Basis Inventory for Tank 241-BY-106 as of August 1, 2016*, Rev. 0, Washington River Protection Solutions, LLC, Richland, Washington.
- RPP-RPT-59626, 2022, *Derivation of Best-Basis Inventory for Tank 241-U-204 as of October 1, 2022*, Rev. 1, Washington River Protection Solutions, LLC, Richland, Washington.

HNF-EP-0182
Revision 447

- RPP-RPT-59663, 2022, *Derivation of Best-Basis Inventory for Tank 241-BY-107 as of April 1, 2022*, Rev. 1, Washington River Protection Solutions, LLC, Richland, Washington.
- RPP-RPT-59683, 2016, *Tank 241-AY-102 Monthly Monitoring Report August 2016*, Rev. 0, Washington River Protection Solutions, LLC, Richland, Washington.
- RPP-RPT-59713, 2016, *Derivation of Best- Basis Inventory for Tank 241-AN-105 as of October 1, 2016*, Rev. 0, Washington River Protection Solutions, LLC, Richland, Washington.
- RPP-RPT-59718, 2016, *Derivation of Best-Basis Inventory for Tank 241-AN-103 as of October 1, 2016*, Rev. 0, Washington River Protection Solutions, LLC, Richland, Washington.
- RPP-RPT-59724, 2016, *Derivation of Best- Basis Inventory for Tank 241-AW-101 as of October 1, 2016*, Rev. 0, Washington River Protection Solutions, LLC, Richland, Washington.
- RPP-RPT-59728, 2017, *Retrieval Completion Status Report for Tank 241-AY-102*, Rev. 0, Washington River Protection Solutions, LLC, Richland, Washington.
- RPP-RPT-59736, 2016, *Derivation of Best- Basis Inventory for Tank 241-AN-104 as of October 1, 2016*, Rev. 0, Washington River Protection Solutions, LLC, Richland, Washington.
- RPP-RPT-59767, 2022, *Derivation of Best-Basis Inventory for Tank 241-U-104 as of October 1, 2022*, Rev. 1, Washington River Protection Solutions, LLC, Richland, Washington.
- RPP-RPT-59768, 2022, *Derivation of Best-Basis Inventory for Tank 241-BY-108 as of January 1, 2022*, Rev. 2, Washington River Protection Solutions, LLC, Richland, Washington.
- RPP-RPT-59792, 2016, *Tank 241-AY-102 Monthly Monitoring Report October 2016*, Rev. 0, Washington River Protection Solutions, LLC, Richland, Washington.
- RPP-RPT-59821, 2017, *Derivation of Best-Basis Inventory for Tank 241-TY-106 as of January 1, 2017*, Rev. 0, Washington River Protection Solutions, LLC, Richland, Washington.
- RPP-RPT-59823, 2022, *Derivation of Best-Basis Inventory for Tank 241-BX-108 as of November 1, 2022*, Rev. 1, Washington River Protection Solutions, LLC, Richland, Washington.
- RPP-RPT-59836, 2016, *Tank 241-AY-102 Monthly Monitoring Report November 2016*, Rev. 0, Washington River Protection Solutions, LLC, Richland, Washington.
- RPP-RPT-59837, 2024, *Derivation of Best-Basis Inventory for Tank 241-B-111 as of July 1, 2024*, Rev. 1, Washington River Protection Solutions, LLC, Richland, Washington.
- RPP-RPT-59838, 2022, *Derivation of Best-Basis Inventory for Tank 241-BY-109 as of February 1, 2022*, Rev. 2, Washington River Protection Solutions, LLC, Richland, Washington.
- RPP-RPT-59854, 2023, *Derivation of Best-Basis Inventory for Tank 241-AX-103 as of April 1, 2023*, Rev. 5, Washington River Protection Solutions, LLC, Richland, Washington.
- RPP-RPT-59855, 2022, *Derivation of Best-Basis Inventory for Tank 241-C-202 as of May 1, 2022*, Rev. 1, Washington River Protection Solutions, LLC, Richland, Washington.
- RPP-RPT-59860, 2022, *Derivation of Best-Basis Inventory for Tank 241-C-203 as of May 1, 2022*, Rev. 1, Washington River Protection Solutions, LLC, Richland, Washington.
- RPP-RPT-59876, 2024, *Derivation of Best-Basis Inventory for Tank 241-BY-110 as of July 1, 2024*, Rev. 1, Washington River Protection Solutions, LLC, Richland, Washington.

- RPP-RPT-59883, 2020, *Derivation of Best-Basis Inventory for Tank 241-BX-112 as of November 1, 2020*, Rev. 1, Washington River Protection Solutions, LLC, Richland, Washington.
- RPP-RPT-59885, 2017, *Tank 241-AY-102 Monthly Monitoring Report December 2016*, Rev. 0, Washington River Protection Solutions, LLC, Richland, Washington.
- RPP-RPT-59887, 2020, *Derivation of Best-Basis Inventory for Tank 241-BX-107 as of July 1, 2020*, Rev. 3, Washington River Protection Solutions, LLC, Richland, Washington.
- RPP-RPT-59892, 2026, *Derivation of Best-Basis Inventory for Tank 241-A-101 as of January 1, 2025*, Rev. 5, Hanford Tank Waste Operations & Closure, LLC, Richland, Washington.
- RPP-RPT-59895, 2022, *Derivation of Best-Basis Inventory for Tank 241-C-204 as of September 1, 2022*, Rev. 1, Washington River Protection Solutions, LLC, Richland, Washington.
- RPP-RPT-59896, 2023, *Derivation of Best-Basis Inventory for Tank 241-U-102 as of January 1, 2023*, Rev. 1, Washington River Protection Solutions, LLC, Richland, Washington.
- RPP-RPT-59897, 2022, *Derivation of Best-Basis Inventory for Tank 241-U-105 as of August 1, 2022*, Rev. 2, Washington River Protection Solutions, LLC, Richland, Washington.
- RPP-RPT-59906, 2022, *Derivation of Best-Basis Inventory for Tank 241-U-103 as of October 1, 2022*, Rev. 2, Washington River Protection Solutions, LLC, Richland, Washington.
- RPP-RPT-59918, 2024, *Derivation of Best-Basis Inventory for Tank 241-BX-104 as of July 1, 2024*, Rev. 2, Washington River Protection Solutions, LLC, Richland, Washington.
- RPP-RPT-59923, 2021, *Derivation of Best-Basis Inventory for Tank 241-TX-104 as of October 1, 2021*, Rev. 1, Washington River Protection Solutions, LLC, Richland, Washington.
- RPP-RPT-59933, 2022, *Derivation of Best-Basis Inventory for Tank 241-U-109 as of November 1, 2022*, Rev. 3, Washington River Protection Solutions, LLC, Richland, Washington.
- RPP-RPT-59955, 2021, *Derivation of Best-Basis Inventory for Tank 241-BX-105 as of July 1, 2021*, Rev. 1, Washington River Protection Solutions, LLC, Richland, Washington.
- RPP-RPT-59959, 2023, *Derivation of Best-Basis Inventory for Tank 241-TX-116 as of April 1, 2023*, Rev. 1, Washington River Protection Solutions, LLC, Richland, Washington.
- RPP-RPT-59973, 2023, *Derivation of Best-Basis Inventory for Tank 241-C-103 as of January 1, 2023*, Rev. 1, Washington River Protection Solutions, LLC, Richland, Washington.
- RPP-RPT-59981, 2025, *Derivation of Best-Basis Inventory for Tank 241-AP-108 as of January 1, 2025*, Rev. 12, Hanford Tank Waste Operations & Closure, LLC, Richland, Washington.
- RPP-RPT-60009, 2020, *Derivation of Best-Basis Inventory for Tank 241-BX-106 as of July 1, 2020*, Rev. 2, Washington River Protection Solutions, LLC, Richland, Washington.
- RPP-RPT-60044, 2021, *Derivation of Best-Basis Inventory for Tank 241-B-106 as of October 1, 2021*, Rev. 1, Washington River Protection Solutions, LLC, Richland, Washington.
- RPP-RPT-60053, 2022, *Derivation of Best-Basis Inventory for Tank 241-TX-113 as of August 1, 2022*, Rev. 1, Washington River Protection Solutions, LLC, Richland, Washington.

HNF-EP-0182
Revision 447

- RPP-RPT-60075, 2023, *Derivation of Best-Basis Inventory for Tank 241-S-105 as of July 1, 2023*, Rev. 2, Washington River Protection Solutions, LLC, Richland, Washington.
- RPP-RPT-60093, 2018, *Fiscal Year 2017 Visual Inspection Report for Single-Shell Tanks*, Rev. 0, Washington River Protection Solutions, LLC, Richland, Washington.
- RPP-RPT-60106, 2025, *Derivation of Best-Basis Inventory for Tank 241-B-107 as of January 1, 2025*, Rev. 2, Washington River Protection Solutions, LLC, Richland, Washington.
- RPP-RPT-60124, 2023, *Derivation of Best-Basis Inventory for Tank 241-C-106 as of October 1, 2023*, Rev. 2, Washington River Protection Solutions, LLC, Richland, Washington.
- RPP-RPT-60128, 2020, *Derivation of Best-Basis Inventory for Tank 241-BX-109 as of October 1, 2020*, Rev. 1, Washington River Protection Solutions, LLC, Richland, Washington.
- RPP-RPT-60140, 2022, *Derivation of Best-Basis Inventory for Tank 241-BY-104 as of April 1, 2022*, Rev. 1, Washington River Protection Solutions, LLC, Richland, Washington.
- RPP-RPT-60167, 2022, *Derivation of Best-Basis Inventory for Tank 241-BY-112 as of July 1, 2022*, Rev. 3, Washington River Protection Solutions, LLC, Richland, Washington.
- RPP-RPT-60184, 2024, *Derivation of Best-Basis Inventory for Tank 241-SX-104 as of January 1, 2024*, Rev. 2, Washington River Protection Solutions, LLC, Richland, Washington.
- RPP-RPT-60185, 2022, *Derivation of Best-Basis Inventory for Tank 241-B-108 as of January 1, 2022*, Rev. 2, Washington River Protection Solutions, LLC, Richland, Washington.
- RPP-RPT-60196, 2017, *Tank 241-AY-102 Monthly Monitoring Report May 2017*, Rev. 0, Washington River Protection Solutions, LLC, Richland, Washington.
- RPP-RPT-60233, 2023, *Derivation of Best-Basis Inventory for Tank 241-S-106 as of July 1, 2023*, Rev. 3, Washington River Protection Solutions, LLC, Richland, Washington.
- RPP-RPT-60241, 2017, *Tank 241-AY-102 Monthly Monitoring Report June 2017*, Rev. 0, Washington River Protection Solutions, LLC, Richland, Washington.
- RPP-RPT-60250, 2024, *Derivation of Best-Basis Inventory for Tank 241-S-109 as of October 1, 2024*, Rev. 2, Washington River Protection Solutions, LLC, Richland, Washington.
- RPP-RPT-60305, 2022, *Single-Shell Tank Updated Drainable Interstitial Liquid Volumes – 2020*, Rev. 3, Washington River Protection Solutions, LLC, Richland, Washington.
- RPP-RPT-60344, 2017, *Tank 241-AY-102 Monthly Monitoring Report July 2017*, Rev. 0, Washington River Protection Solutions, LLC, Richland, Washington.
- RPP-RPT-60346, 2022, *Derivation of Best-Basis Inventory for Tank 241-S-101 as of July 1, 2022*, Rev. 1, Washington River Protection Solutions, LLC, Richland, Washington.
- RPP-RPT-60349, 2023, *Derivation of Best-Basis Inventory for Tank 241-S-103 as of July 1, 2023*, Rev. 2, Washington River Protection Solutions, LLC, Richland, Washington.
- RPP-RPT-60372, 2019, *Derivation of Best-Basis Inventory for Tank 241-S-107 as of April 1, 2023*, Rev. 2, Washington River Protection Solutions, LLC, Richland, Washington.
- RPP-RPT-60377, 2021, *Derivation of Best-Basis Inventory for Tank 241-S-112 as of October 1, 2021*, Rev. 1, Washington River Protection Solutions, LLC, Richland, Washington.

HNF-EP-0182
Revision 447

- RPP-RPT-60380, 2023, *Derivation of Best-Basis Inventory for Tank 241-U-106 as of January 1, 2023*, Rev. 2, Washington River Protection Solutions, LLC, Richland, Washington.
- RPP-RPT-60410, 2021, *Derivation of Best-Basis Inventory for Tank 241-SX-101 as of April 1, 2021*, Rev. 2, Washington River Protection Solutions, LLC, Richland, Washington.
- RPP-RPT-60434, 2023, *Derivation of Best-Basis Inventory for Tank 241-SX-105 as of July 1, 2023*, Rev. 2, Washington River Protection Solutions, LLC, Richland, Washington.
- RPP-RPT-60435, 2017, *Tank 241-AY-102 Monthly Monitoring Report September 2017*, Rev. 0, Washington River Protection Solutions, LLC, Richland, Washington.
- RPP-RPT-60473, 2023, *Derivation of Best-Basis Inventory for Tank 241-S-110 as of July 1, 2023*, Rev. 2, Washington River Protection Solutions, LLC, Richland, Washington.
- RPP-RPT-60474, 2024, *Derivation of Best-Basis Inventory for Tank 241-S-104 as of January 1, 2024*, Rev. 3, Washington River Protection Solutions, LLC, Richland, Washington.
- RPP-RPT-60487, 2025, *Derivation of Best-Basis Inventory for Tank 241-SX-108 as of January 1, 2025*, Rev. 2, Washington River Protection Solutions, LLC, Richland, Washington.
- RPP-RPT-60498, 2022, *Derivation of Best-Basis Inventory for Tank 241-U-110 as of August 1, 2022*, Rev. 1, Washington River Protection Solutions, LLC, Richland, Washington.
- RPP-RPT-60514, 2022, *Derivation of Best-Basis Inventory for Tank 241-U-107 as of October 1, 2022*, Rev. 2, Washington River Protection Solutions, LLC, Richland, Washington.
- RPP-RPT-60519, 2024, *Derivation of Best-Basis Inventory for Tank 241-SX-103 as of January 1, 2024*, Rev. 2, Washington River Protection Solutions, LLC, Richland, Washington.
- RPP-RPT-60540, 2024, *Derivation of Best-Basis Inventory for Tank 241-SY-103 as of January 1, 2024*, Rev. 1, Washington River Protection Solutions, LLC, Richland, Washington.
- RPP-RPT-60565, 2018, *Fiscal Year 2018 Visual Inspection Report for Single-Shell Tanks*, Rev. 0, Washington River Protection Solutions, LLC, Richland, Washington.
- RPP-RPT-60574, 2021, *Derivation of Best-Basis Inventory for Tank 241-U-112 as of December 1, 2021*, Rev. 2, Washington River Protection Solutions, LLC, Richland, Washington.
- RPP-RPT-60584, 2017, *Tank 241-AY-102 Monthly Monitoring Report November 2017*, Rev. 0, Washington River Protection Solutions, LLC, Richland, Washington.
- RPP-RPT-60606, 2019, *Derivation of Best-Basis Inventory for Tank 241-TX-118 as of July 1, 2019*, Rev. 1, Washington River Protection Solutions, LLC, Richland, Washington.
- RPP-RPT-60611, 2022, *Derivation of Best-Basis Inventory for Tank 241-U-108 as of January 1, 2022*, Rev. 0, Washington River Protection Solutions, LLC, Richland, Washington.
- RPP-RPT-60713, 2018, *Tank 241-AY-102 Monthly Monitoring Report January 2018*, Rev. 0, Washington River Protection Solutions, LLC, Richland, Washington.
- RPP-RPT-60717, 2018, *Retrieval Completion Certification Report for Tank 241-C-105*, Rev. 0, Washington River Protection Solutions, LLC, Richland, Washington.
- RPP-RPT-60731, 2018, *Post-Retrieval Camera/CAD Modeling System Waste Volume Estimate for Tank 241-C-105*, Rev. 0, Washington River Protection Solutions, LLC, Richland, Washington.

HNF-EP-0182
Revision 447

- RPP-RPT-61200, 2019, *Fiscal Year 2019 Visual Inspection Report for Single-Shell Tanks*, Rev. 0, Washington River Protection Solutions, LLC, Richland, Washington.
- RPP-RPT-61279, 2019, *Single-Shell Tank Farm Leak Inventory Assessments Summary*, Rev. 0, Washington River Protection Solutions, LLC, Richland, Washington.
- RPP-RPT-62005, 2020, *Fiscal Year 2020 Visual Inspection Report for Single-Shell Tanks*, Rev. 0, Washington River Protection Solutions, LLC, Richland, Washington.
- RPP-RPT-62066, 2020, *Single-Shell Tank 241-AX-102 Retrieval Completion Report*, Rev. 1, Washington River Protection Solutions, LLC, Richland, Washington.
- RPP-RPT-62815, 2021, *Fiscal Year 2021 Visual Inspection Report for Single-Shell Tanks*, Rev. 0, Washington River Protection Solutions, LLC, Richland, Washington.
- RPP-RPT-63206, 2021, *Retrieval Completion Certification Report for Tank 241-AX-102*, Rev. 0, Washington River Protection Solutions, LLC, Richland, Washington.
- RPP-RPT-63243, *Laser Scanning Waste Volume Estimate for Tank 241-AX-104*, Rev. 0, Washington River Protection Solutions, LLC, Richland, Washington.
- RPP-RPT-63643, *Retrieval Completion Certificate for Tank 241-AX-104*, Rev. 0, Washington River Protection Solutions, LLC, Richland, Washington.
- RPP-RPT-63731, *Estimated Leak Volume for Single-Shell Tank 241-B-109*, Rev. 0, Washington River Protection Solutions, LLC, Richland, Washington.
- RPP-RPT-63741, 2022, *Derivation of Best-Basis Inventory for Tank 241-C-301 as of July 1, 2022*, Rev. 0, Washington River Protection Solutions, LLC, Richland, Washington.
- RPP-RPT-65071, 2024, *2024 Leak Assessment Report for Tank 241-T-101*, Rev. 0, Washington River Protection Solutions, LLC, Richland, Washington.
- RPP-TE-58839, 2022, *Water Intrusion into Single-Shell Tank 241-S-102*, Rev. 0, Washington River Protection Solutions, LLC, Richland, Washington.
- RPP-TE-58842, 2022, *Water Intrusion into Single-Shell Tank 241-C-204*, Rev. 0, Washington River Protection Solutions, LLC, Richland, Washington.
- RPP-TE-58843, 2022, *Water Intrusion into Single-Shell Tank 241-C-203*, Rev. 0, Washington River Protection Solutions, LLC, Richland, Washington.
- RPP-TE-58845, 2022, *Water Intrusion into Single-Shell Tank 241-C-202*, Rev. 0, Washington River Protection Solutions, LLC, Richland, Washington.
- RPP-TE-58847, 2022, *Water Intrusion into Single-Shell Tank 241-C-201*, Rev. 0, Washington River Protection Solutions, LLC, Richland, Washington.
- RPP-TE-58907, 2023, *Technical Evaluation of Tank 241-S-107 Waste Surface Level Trend*, Rev. 0, Washington River Protection Solutions, LLC, Richland, Washington.
- RPP-TE-59025, 2024, *Technical Evaluation of Potential Intrusion into Tank 241-TX-101*, Rev. 0, Washington River Protection Solutions, LLC, Richland, Washington.

- Sax, S. M., 2010, "Contract Number DE AC27 08RV14800 – Washington River Protection Solutions, LLC Transmittal of the Single-Shell Tank Interim Stabilization Evaluation Report for Tank 241-S-102," (Letter WRPS-1000772 R1 to S. L. Charboneau, U.S. Department of Energy, Office of River Protection, June 1), Washington River Protection Solutions, LLC, Richland, Washington.
- Schepens, R. J., 2006a, "Process for Reaching Agreement on Tank Farm Vadose Zone Leak Loss Estimate," (Letter 06-TPD-059 to J. Hedges, Washington State Department of Ecology, August 18), U.S. Department of Energy, Office of River Protection, Richland, Washington.
- Schepens, R. J., 2006b, "Submittal of the Demonstration Retrieval Data Report (RDR) for Single-Shell Tank 241-C-201, RPP-RPT-30181, Revision 0A," (Letter 06-TPD-071 to J. Hedges, Washington State Department of Ecology, November 2), U.S. Department of Energy, Office of River Protection, Richland, Washington.
- Schepens, R. J., 2006c, "Submittal of Demonstration Retrieval Data Report (RDR) for Single-Shell Tank C-202, RPP-RPT-29095, Rev. 0," (Letter 06-TPD-051 to J. Hedges, Washington State Department of Ecology, July 31), U.S. Department of Energy, Office of River Protection, Richland, Washington.
- Schepens, R. J., 2006d, "Submittal of Demonstration Retrieval Data Report (RDR) for Single-Shell Tank C-203, RPP-RPT-26475, Rev. 1," (Letter 06-TPD-005 to J. Hedges, Washington State Department of Ecology, January 18), U.S. Department of Energy, Office of River Protection, Richland, Washington.
- Schepens, R. J., 2006e, "Notification of Completion of Pumping Liquids from Catch Tank 244-UX302A and Start of Evaporation of Liquid from Catch Tank 241-ER-311," (Letter 06-TOD-090 to J. Hedges, Washington State Department of Ecology, November 1), U.S. Department of Energy, Office of River Protection, Richland, Washington.
- Schofield, J. S., 2018, "FY18 Visual Inspection of Tank 241-C-301," (Interoffice Memorandum WRPS-1803745 to R.E. Mendoza, September 10), Washington River Protection Solutions, LLC, Richland, Washington.
- SD-WM-SAR-006, 1986, *Single-Shell Tank Isolation Safety Analysis Report*, Rev. 2, Rockwell Hanford Operations, Richland, Washington.
- Smith, K. W., 2013a, "The U.S. Department of Energy, Office of River Protection (ORP) Submits the Retrieval Completion Certification and Report for Tank 241-C-109," (Letter 13-TF-0037 to J. A. Hedges, Washington State Department of Ecology, June 4), U.S. Department of Energy, Office of River Protection, Richland, Washington.
- Smith, K. W., 2013b, "The U.S. Department of Energy, Office of River Protection (ORP) Submits the Retrieval Completion Certification and Report for Tank 241-C-108," (Letter 13-TF-0120 to J. A. Hedges, Washington State Department of Ecology, November 27), U.S. Department of Energy, Office of River Protection, Richland, Washington.
- Smith, K. W., 2014a, "The U.S. Department of Energy, Office of River Protection Submits the Retrieval Completion Certification and Report for Tank 241-C-110," (Letter 14-TF-0007 to J. A. Hedges, Washington State Department of Ecology, January 29), U.S. Department of Energy, Office of River Protection, Richland, Washington.

- Smith, K. W., 2014b, "The U.S. Department of Energy, Office of River Protection Submits the Retrieval Completion Certification and Report for Tank 241-C-101," (Letter 14-TF-0113 to J. A. Hedges, Washington State Department of Ecology, September 24), U.S. Department of Energy, Office of River Protection, Richland, Washington.
- Smith, K. W., 2014c, "The U.S. Department of Energy, Office of River Protection Submits the Retrieval Completion Certification and Report for Tank 241-C-107," (Letter 14-TF-0114 to J. A. Hedges, Washington State Department of Ecology, September 30), U.S. Department of Energy, Office of River Protection, Richland, Washington.
- Smith, K. W., 2014d, "The U.S. Department of Energy, Office of River Protection Submits the Retrieval Completion Certification and Report for Tank 241-C-112," (Letter 14-TF-0115 to J. A. Hedges, Washington State Department of Ecology, September 30), U.S. Department of Energy, Office of River Protection, Richland, Washington.
- Smith, K. W., 2014e, "The U.S. Department of Energy, Office of River Protection Submits the Retrieval Completion Certification and Report for Tank 241-C-104," (Letter 14-TF-0013 to J. A. Hedges, Washington State Department of Ecology, February 18), U.S. Department of Energy, Office of River Protection, Richland, Washington.
- Smith, K. W., 2014f, "The U.S. Department of Energy, Office of River Protection Submits the Retrieval Completion Certification and Report for Tank 241-C-109," (Letter 14-TF-0020 to J. A. Hedges, Washington State Department of Ecology, March 13), U.S. Department of Energy, Office of River Protection, Richland, Washington.
- Smith, K. W., 2014g, "The U.S. Department of Energy, Office of River Protection Submits the Retrieval Completion Certification and Report for Tank 241-C-110," (Letter 14-TF-0086 to J. A. Hedges, Washington State Department of Ecology, August 6), U.S. Department of Energy, Office of River Protection, Richland, Washington.
- Smith, K. W., 2015a, "The U.S. Department of Energy, Office of River Protection Submits the Retrieval Completion Certification Report for Tank 241-C-102," (Letter 15-TF-0116 to J. A. Hedges, Washington State Department of Ecology, November 30), U.S. Department of Energy, Office of River Protection, Richland, Washington.
- Smith, K. W., 2015b, "The U.S. Department of Energy, Office of River Protection Submits the Retrieval Completion Certification Report for Tank 241-C-101," (Letter 15-TF-0099 to J. A. Hedges, Washington State Department of Ecology, September 24), U.S. Department of Energy, Office of River Protection, Richland, Washington.
- Smith, K. W., 2015c, "The U.S. Department of Energy, Office of River Protection Submits the Retrieval Completion Certification Report for Tank 241-C-112," (Letter 15-TF-0098 to J. A. Hedges, Washington State Department of Ecology, September 30), U.S. Department of Energy, Office of River Protection, Richland, Washington.
- Smith, K. W., 2015d, "The U.S. Department of Energy, Office of River Protection Submits the Retrieval Completion Certification Report for Tank 241-C-107," (Letter 15-TF-0086 to J. A. Hedges, Washington State Department of Ecology, September 14), U.S. Department of Energy, Office of River Protection, Richland, Washington.

- Smith, K. W., 2016a, "The U.S. Department of Energy, Office of River Protection Submits the Retrieval Completion Certification Report for Tank 241-C-111," (Letter 16-TF-0090 to Alexandra K. Smith, Washington State Department of Ecology, August 29), U.S. Department of Energy, Office of River Protection, Richland, Washington.
- Smith, K. W., 2016b, "The U.S. Department of Energy, Office of River Protection Submits the Retrieval Data Report for Tank 241-C-102," (Letter 16-TF-0115 to A. K. Smith, Washington State Department of Ecology, October 11, 2016), U.S. Department of Energy, Office of River Protection, Richland, Washington.
- Smith, K. W., 2017a, "The U.S. Department of Energy, Office of River Protection and Washington River Protection Solutions LLC Completion of II.B.5.A of the 241-AY-102 Settlement Agreement" (Letter 17-TF-0021 to Alexandra K. Smith, Washington State Department of Ecology, February 23), U.S. Department of Energy, Office of River Protection, Richland, Washington.
- Smith, K. W., 2017b, "The U.S. Department of Energy, Office of River Protection and Washington River Protection Solutions Completion of II.B.5.B of the 241-AY-102 Settlement Agreement" (Letter 17-TF-0030 to Alexandra K. Smith, Washington State Department of Ecology, March 13), U.S. Department of Energy, Office of River Protection, Richland, Washington.
- Smith, K. W., 2017c, "The U.S. Department of Energy, Office of River Protection Submits the Retrieval Data Report for Tank 241-C-111," (Letter 17-TPD-0018 to A. K. Smith, Washington State Department of Ecology, August 11, 2017), U.S. Department of Energy, Office of River Protection, Richland, Washington.
- Smith, K. W., 2020, "U.S. Department of Energy Rescinds "Request for Waiver to Hanford Federal Facility Agreement and Consent Order Waste Retrieval Criteria for Single Shell Tank 241-C-106"" (Letter 20-ECD-0016 to A.K. Smith, Washington State Department of Ecology, and D. Einan, U.S. Environmental Protection Agency, April 1, 2020), U.S. Department of Energy, Office of River Protection, Richland, Washington.
- TOC-ENV-NOT-2014-4032, 2014, Notification for Intrusion Detected in 244-AR Cell 3 Sump, Washington River Protections Solutions, LLC, Richland, Washington.
- TOC-ENV-NOT-2017-4352, 2017, Completion of Limit of Technology for AY-102 Retrieval, Environmental Operational Activities Notification, Washington River Protections Solutions, LLC, Richland, Washington.
- TOC-ENV-NOT-2018-4530, 2018, Intrusion into Miscellaneous Underground Storage Tank TX-302-C, Washington River Protections Solutions, LLC, Richland, Washington.
- TOC-ENV-NOT-2019-4546, 2019, Intrusion into Single-Shell Tank 241-U-109, Miscellaneous Underground Storage Tanks 241-A-302A and 241-A-350, Washington River Protections Solutions, LLC, Richland, Washington.
- TOC-ENV-NOT-2019-4560, 2019, Notification of Intrusion in Storage Tanks Subject to Requirements of RPP-9937, Washington River Protections Solutions, LLC, Richland, Washington.

HNF-EP-0182
Revision 447

- TOC-ENV-NOT-2023-4703, 2023, Notification of Change of Status of Tank 242-TX-116 from “Assumed Leaker” to “Sound,” Washington River Protections Solutions, LLC, Richland, Washington.
- TOC-ENV-NOT-2025-4754, 2025, Tank 241-TX-302B Intrusion RPP-9937, Hanford Tank Waste Operations & Closure, LLC, Richland, Washington.
- TFC-ENG-CHEM-D-42, 2019, “Tank Leak Assessment Process,” Rev. B-11, Washington River Protections Solutions, LLC, Richland, Washington.
- TFC-ENG-CHEM-P-57, 2023, “Tank Leak and Intrusion Assessment and Response,” A-3, Washington River Protections Solutions, LLC, Richland, Washington.
- TFC-WO-11-5930 WCN-2, 2012, “241-UX-302A Pumping Liquid out of Tank,” Washington River Protections Solutions, LLC, Richland, Washington.
- Vance, B. T., 2018, “The U. S. Department of Energy Office of River Protection Submits the Retrieval Completion Certification Report for Tank 241-C-105,” (Letter 18-TF-0044 to A. K. Smith, Washington State Department of Ecology, June 28, 2018), U.S. Department of Energy, Office of River Protection, Richland, Washington.
- Vance, B. T., 2019, “The U. S. Department of Energy Office of River Protection Submits the Retrieval Data Report for Tank 241-C-105,” (Letter 19-TPD-0011 to A. K. Smith, Washington State Department of Ecology, June 21, 2019), U.S. Department of Energy, Office of River Protection, Richland, Washington.
- Vance, B. T., 2020, “The U. S. Department of Energy Rescinds “Request for Waiver to Hanford Federal Facility Agreement and Consent Order Waste Retrieval Criteria for Single-Shell Tank 241-C-106” (Letter 20-ECD-0016 to A. K. Smith, Washington State Department of Ecology, April 1, 2020), U.S. Department of Energy, Office of River Protection, Richland, Washington.
- Vance, B. T., 2021, “The U. S. Department of Energy Office of River Protection Submits the Retrieval Certification Report for Tank 241-AX-102,” (Letter 21-TF-002570 to D. B. Bowen, Washington State Department of Ecology, September 13, 2021), U.S. Department of Energy, Office of River Protection, Richland, Washington.
- Vance, B. T., 2022, “The U. S. Department of Energy Office of River Protection Submits the Retrieval Data Report for Tank 241-AX-102,” (Letter 22-TF-002556 to D. B. Bowen, Washington State Department of Ecology, September 6, 2022), U.S. Department of Energy, Office of River Protection, Richland, Washington.
- Vance, B. T., 2023, “The U.S. Department of Energy Submits RPP-RPT-63983, *Retrieval Completion Certification Report for Tank 241-AX-103*, Rev. 0, to the Washington State Department of Ecology,” (Letter 23-TF-000067 to D. B. Bowen, Washington State Department of Ecology, January 17, 2023), U.S. Department of Energy, Office of River Protection, Richland, Washington.
- Vance, B. T., 2022, “The U. S. Department of Energy Office of River Protection Submits the Retrieval Completion Certification Report for Tank 241-AX-104,” (Letter 22-TF-002824 to D. B. Bowen, Washington State Department of Ecology, September 29, 2022), U.S. Department of Energy, Office of River Protection, Richland, Washington.

HNF-EP-0182
Revision 447

- WAC 173-303-070, "Dangerous Waste Regulations," Section 70, "Designation of Dangerous Waste," *Washington Administrative Code*, as amended, Washington State Department of Ecology, Olympia, Washington.
- WHC-EP-0410, 1991, *Tank 241-A-105 Evaporation Estimate 1970 through 1978*, Westinghouse Hanford Company, Richland, Washington.
- WHC-MR-0264, 1991, *Tank 241-A-105 Leak Assessment*, Westinghouse Hanford Company, Richland, Washington.
- WHC-MR-0300, 1992, *Tank 241-SX-108 Leak Assessment*, Westinghouse Hanford Company, Richland, Washington. WHC-MR-0301, 1992, *Tank 241-SX-109 Leak Assessment*, Westinghouse Hanford Company, Richland, Washington.
- WHC-MR-0302, 1992, *Tank 241-SX-115 Leak Assessment*, Westinghouse Hanford Company, Richland, Washington.
- WHC-SD-WM-SAR-040, 1991, *Safety Analysis Report for the 204-AR Waste Unloading Facility*, Rev. 1, Westinghouse Hanford Company, Richland, Washington.
- WHC-TANKFARM-1992-0073, 1992, "Apparent Decrease in Liquid Level in Single Shell Underground Storage Tank 241-T-101, Leak Suspected; Investigation Continuing," Westinghouse Hanford Company, Richland, Washington.
- WHC-TANKFARM-1994-0009, 1994, "Apparent Liquid Level Decrease in Single Shell Underground Storage Tank 241-T-111; Declared an Assumed Re-Leaker," Westinghouse Hanford Company, Richland, Washington.

7.0 APPENDIX A – GLOSSARY

Term (abbreviation)	Definition or expansion
Administratively Interim Stabilized	A tank that meets interim stabilization criteria without the use of a jet pump, typically tanks that contained small waste inventories or experienced high rates of evaporation.
Annulus	The space between the inner and outer shells in DSTs only. Drain channels in the insulating and/or supporting concrete carry any leakage to the annulus space where Enraf® gauges are installed. The Enraf® gauges are the primary means of leak detection for all DSTs. The leak detection system may not be replaced by, but may be supplemented by, the operation of an annulus ventilation system CAM.
Annulus Pump Pit	The DST concrete pit used for the pump and piping required to empty waste from the annular space between the primary tank and secondary tank in the event of a leak from the primary tank. The annulus pump pit is connected to the DST center pump pit via installed underground piping; from the center pump pit, the waste will be returned to the primary tank or transferred to another DST. Primary tank emergency pumping using the annulus pump pit is described in HNF-3484. ^a
Assumed Leaker^b	The integrity classification of a waste storage tank for which surveillance data indicates a loss of liquid to the environment attributed to a breach of integrity.
Assumed Leaker – Primary Tank^b	The integrity classification of a DST for which surveillance data indicate a loss of liquid attributed to a breach of primary tank integrity.
Characterization	An understanding of the Hanford tank waste chemical, physical, and radiological properties to the extent necessary to ensure safe storage and interim operation, and ultimate disposition of the waste.
Closure	Final closure of the operable units (tank farms) is defined as regulatory approval of completion of closure actions and commencement of post-closure actions. Per the <i>Hanford Federal Facility Agreement and Consent Order</i> ^c Change Control Form, Change Number M-45-02-03, all units located within the boundary of each tank farm will be closed in accordance with WAC 173-303-610. ^d
Continuous Air Monitor (CAM)	The CAM passes a small portion of the DST annulus space exhaust airstream through filter paper that is continuously monitored for radiation. If airborne radioactive contamination is present in the annulus, it will collect on the filter paper. When the radiation count rate exceeds the preset alarm threshold, local and remote alarms are triggered.
Drainable Interstitial Liquid (DIL)	DIL is defined as the volume of interstitial liquid (i.e., liquid in the pores around the waste particles) estimated to drain from a tank if a hole was present in the bottom centerline of an SST through both the steel liner and the concrete shell. The calculated DIL volume in a tank is dependent on waste volume, liquid level, waste porosity, and capillary height (RPP-RPT-60305).
Drywells	Drywells are open bottom 6-in. or 8-in. steel casings placed vertically around an SST perimeter and extending between 75 ft and 200 ft below-grade. Historically, the drywells were monitored with gross gamma radiation logging tools as part of a secondary leak monitoring system. In some cases, neutron probes were used to monitor moisture in the soil as a function of well depth, which could be indicative of tank leakage. The routine gross gamma logging data were stored electronically from 1974 through 1994; a program was initiated in 1995 to log each of the available drywells in each tank farm with a spectral gamma logging system. The spectral gamma logging system provides quantitative values for gamma-emitting radionuclides. The baseline spectral gamma logging database is available electronically. The terms “drywells” and “boreholes” are used interchangeably.

Term (abbreviation)	Definition or expansion
Enraf® 854 ATG Level Detector	The Enraf® gauge, fabricated by Honeywell, determines waste level by detecting variations in the weight of a displacer lowered to the tank waste surface. Enraf® gauges transmit digital level data to TMACS via an Enraf® computer interface unit or to TFMCS via an interface unit manufactured by Gauging Systems Incorporated (GSI). Both TMACS and TFMCS transmit data to the OSISoft PI Historian so data may be displayed to HLAN users. The Enraf®/GSI computer interfaces allow fully remote communication with the gauge, minimizing tank farm entry.
Interim Stabilization	A tank that contains less than 50 kgal of DIL and less than 5 kgal of supernatant is interim-stabilized. If a jet pump was used to achieve interim stabilization, the jet pump flow or saltwell screen inflow must also have been at or below 0.05 gal/min before interim stabilization criteria are met. The basis for the 50 kgal DIL value and 0.05 gal/min value are in RHO-CD-1273.
Interstitial Liquid Level	The height of the residual liquid occupying the interstitial spaces in the solid waste heel of an interim stabilized SST.
Intrusion Prevention	The administrative designation reflecting the completion of the physical effort required to minimize the addition of liquids into an inactive storage tank, process vault, sump, catch tank, or diversion box. Under no circumstances are electrical or instrumentation devices disconnected or disabled during the intrusion prevention process (except for the electrical pump), in accordance with SD-WM-SAR-006. ^e
Jet Pump	The centrifugal pump and jet assembly used to pump the interstitial liquid from the saltwell screen into the pump pit, nominally a 40-ft elevation rise. Pumping rates vary from 0.05 to about 4 gal/min.
Laterals	Laterals are horizontal drywells positioned 8 to 10 ft under SSTs, three per tank, to detect radionuclides in the soil that could be indicative of tank leakage. These drywells can be monitored by radiation detection probes. Laterals are located only in A and SX Farms. There are currently no functioning laterals and no plan to prepare them for use.
Leak Detection Pits	Enclosed sumps collect drainage from the concrete foundations of the four AX Farm SSTs and the 28 DSTs. In the event of a breach of containment of the SST or the DST secondary tank, the leak detection pit drain system collects leakage from the drain channels cast in the foundation and directs it to the leak detection pit where it can be pumped to a nearby sound DST. A leak is detected by an increase in the leak detection pit liquid level. Only DST leak detection pits are monitored for increases.
Liquid Observation Well (LOW)	In-tank LOWs are used for monitoring the interstitial liquid level in SSTs. The wells are usually constructed of fiberglass or TEFZEL ^f F-reinforced epoxy-polyester resin. A few LOWs are constructed of steel. Gamma and neutron probes are used to monitor changes in the interstitial liquid level and can indicate intrusions or leakage by increases or decreases in the interstitial liquid level. OSD-T-151-00031, ^g identifies which LOWs are designated as the primary monitoring device in the SSTs. All the SST LOWs are monitored quarterly. Two LOWs installed in DSTs SY-102 and AW-103 are used for special, rather than routine, surveillance purposes only.
Modified Sluicing	Modified sluicing sprays supernatant or water onto the surface of SST waste to mobilize it to a slurry and direct it to the inlet of the slurry pump. The pump transfers the slurry to a DST where the slurry is allowed to settle out. The clarified liquid is pumped back to the SST sluicers for reuse. The method is referred to as <i>modified sluicing</i> to differentiate it from historical <i>past-practice sluicing</i> that used significantly higher sluice pressures and flow rates, and greater volumes.
Nominal Volume of Remaining Waste	Nominal volume of remaining waste is the best estimate of residual volume following retrieval. Retrieval data reports also provide the 95 percent upper confidence level volume as the bounding estimate of remaining waste.

Term (abbreviation)	Definition or expansion
Primary Tank	The metal inner tank of the DST structure that holds the radioactive liquid waste. The primary tank is constructed of high strength, stress-relieved steel to minimize the potential for cracking and is monitored for corrosion and leakage once placed in service.
Retrieval	Retrieval is the process of removing, to the maximum extent practical, all the waste from a given underground storage tank. The retrieval process is selected specific to each tank and accounts for the waste type stored and the access and support systems available. Per OSD-T-151-00031, ^g a tank is officially in “retrieval status” if one of two conditions is met: (1) waste has been physically removed from the tank by retrieval operations, or (2) preparations for retrieval operations are directly responsible for rendering the leak or intrusion monitoring instrument “out-of-service.”
Saltcake	Saltcake is soluble salts in waste storage tanks formed by the evaporation of liquid waste from nuclear reactor fuels reprocessing, and is characterized by high porosity, interstitial liquid’s ability to drain, and crystalline texture.
Saltwell Screen	The saltwell screen is a 10-in. diameter casing consisting of a stainless steel saltwell screen welded to a Schedule 40 carbon steel pipe. The casing and screen are to be inserted into a 12-in. tank riser located in the pump pit. The stainless-steel screen portion of the system extends through the tank waste to near the bottom of the tank.
Secondary Tank	The metal outer tank of the DST structure that holds radioactive liquid waste in the event of a breach in the primary tank. The annular space between the primary and secondary tanks is equipped with continuous leak detection to provide early warning of a primary tank leak and an access pit for insertion of emergency pumping equipment.
Sludge	Sludge is the insoluble hydrated metal oxides and fission products in waste storage tanks from nuclear reactor fuels reprocessing, and is characterized by low porosity, reduced ability for interstitial liquid to drain, and mud-like texture.
Sound^a	The integrity classification of a waste storage tank for which surveillance data indicates no loss of liquid attributed to a breach of integrity.
Supernatant	Supernatant is the liquid above the solids or in large liquid pools in waste storage tanks.
Surface Levels	The surface level in all waste storage tanks is monitored by manual tape probes or Enraf® gauges and recorded and transmitted via the surveillance analysis computer system.
Thermocouple Tree	A thermocouple tree is installed in tanks to collect temperature data for process control and for determining compliance with temperature-based operating specifications. The thermocouple tree is typically a closed, 2-in. diameter steel pipe extending to within 6-in. of the tank bottom. Eighteen or more thermocouples are placed inside the pipe, spaced at vertical intervals of 6-in. to about 24-in., depending on the thermocouple design and intended purpose. Thermocouple leads terminate above-grade in a terminal box monitored locally or by TMACS. SST thermocouple trees that fail are not replaced.
Total Waste	For purposes of this document, total waste is solids volume (sludge and saltcake, including liquids) plus supernatant.
Weight Factor	The weight factor is an indirect method of determining the tank liquid level by measuring the air pressure necessary to overcome the hydrostatic head in an open-end vertical steel pipe terminated about 2-in. above the tank floor. The “uncorrected weight factor” is the difference between the hydrostatic head pressure in the pipe and the air pressure in the tank headspace, expressed in inches of water. To eliminate the liquid density bias that affects the uncorrected weight factor measurement, a second vertical pipe is located in the liquid, terminated 10-in. above the first pipe. The difference in hydrostatic head between the two pipes is converted to specific gravity (i.e., ratio of the liquid density to water density); the uncorrected weight factor divided by the specific gravity yields the “corrected weight factor,” which is the true liquid height in the tank.

Term (abbreviation)	Definition or expansion
Zip Cord	The zip cord is a primitive liquid level detection device consisting of a calibrated insulated wire pair to which electrodes have been attached. To make the measurement, the zip cord is slowly lowered to a point where the liquid surface is contacted by the electrodes. The liquid level reading is recorded when the portable direct current meter connected between the wire leads registers zero ohm resistance.

- ^a RHO-RE-SR-14, 1984, *Waste Status Summary October 1984*, Rockwell Hanford Operations, Richland, Washington.
- ^b Clark, W. C., 2012, “Contract Number DE AC27 08RV1480 – Washington River Protection Solutions, LLC Tank 241-AY-102 Primary Tank Leak Integrity Change from Sound to Assumed Leaker, and Double-Shell Waste Tank Leak Integrity Definitions,” (Letter WRPS-1204634 to T. W. Fletcher, U.S. Department of Energy, Office of River Protection, November 13), Washington River Protection Solutions, LLC, Richland, Washington.
- ^c Ecology, EPA, and DOE, 1989, *Hanford Federal Facility Agreement and Consent Order – Tri-Party Agreement (TPA)*, as amended, Washington State Department of Ecology, U.S. Environmental Protection Agency, and U.S. Department of Energy, Olympia, Washington.
- ^d WAC 173-303-610, “Dangerous Waste Regulations,” Section 610, “Closure and Post-Closure,” *Washington Administrative Code*, as amended, Washington State Department of Ecology, Olympia, Washington.
- ^e SD-WM-SAR-006, 1986, *Single-Shell Tank Isolation Safety Analysis Report*, Rev. 2, Rockwell Hanford Operations, Richland, Washington.
- ^f TEFZEL is a trademark of E. I. du Pont de Nemours & Company, Wilmington, Delaware.
- ^g OSD-T-151-00031, 2021, *Operating Specifications for Tank Farm Leak Detection and Single-Shell Tank Intrusion Detection*, Rev. 20, Washington River Protection Solutions, LLC, Richland, Washington.

CAM = continuous air monitor.

DIL = drainable interstitial liquid.

DST = double-shell tank.

LOW = liquid observation well.

SST = single-shell tank.

TMACS = tank monitor and control system.

WAC = Washington Administrative Code.

DISTRIBUTION LIST**OFFSITE – USA**

Number of copies	Address
	Congress of the United States
	U.S. Senate 717 Hart Senate Building Washington D.C. 20510 Senator Ron Wyden
2 hard copies	U.S. House of Representatives 1641 Longworth House Office Building Washington D. C. 20515 Congressman Dan Newhouse, 4th District
	U.S. Department of Energy-Headquarters
1 electronic only	Jeffrey Avery jeffrey.avery@em.doe.gov
1 electronic only	John B. Jones john.jones@em.doe.gov
1 electronic only	Johnathan Kang jonathan.kang@em.doe.gov
1 electronic only	Christopher Kemp christopher.kemp@em.doe.gov
1 electronic only	Nicholas P. Machara nicholas.machara@em.doe.gov
1 electronic only	Rod Rimando rodrigo.rimando@em.doe.gov
1 electronic only	Gregory Sosson gregory.sosson@em.doe.gov
	Confederated Tribes of the Umatilla Indian Reservation
1 electronic only	Woodrow Star bot@ctuir.org 46411 Timine Way Pendleton, OR 97801
	Washington State Department of Health
1 hard copy	Office of Radiation Protection 309 Bradley Boulevard, Suite 201 Richland, WA, 99352

Oregon Department of Energy
Hanford and Nuclear Safety
Division Administrator and Oregon Hanford Clean Up Board
550 Capital St. N.E., 1st Floor
Salem, OR 97301-3737
Maxwell Woods.
Maxwell.woods@oregon.gov

1 electronic only

U.S. Defense Nuclear Facilities Safety Board

1 electronic only
Robert Csillag
RobertC@dnfsb.gov

TRI-CITIES

Number of copies	Address
1 electronic copy	Enercon Federal Services Anthony G. Cockbain acockbain@enercon.com
1 electronic copy	C. Hendrix chendrix@enercon.com
1 electronic copy	Tri-City Herald Annette Cary 4253 W. 24th Ave Kennewick, WA 99338 acary@tricityherald.com

ONSITE

Number of copies	Address	Mail Stop
1 electronic only	Government Accountability Office N. K. Kintner-Meyer	A1-80
1 electronic only	J. T. Larson	A1-80
1 electronic only	U.S. Defense Nuclear Facilities Safety Board B. K. Caleca	S7-04
1 electronic only	P. K. Fox	H5-30
1 electronic only	P. A. Meyer	S7-04
1 hard copy 1 electronic only	U.S. Environmental Protection Agency D. R. Einan M. Mullin	A3-46 mullin.michelle@epa.gov
1 electronic only	U.S. Department of Energy R. Bang	H6-60
1 electronic only	M. L. Barkley	H6-60
1 electronic only	R. I. Blackwell	H5-20
1 electronic only	J. J. Carter	H6-60
1 electronic only	L. M. Caulfield	H6-60
1 electronic only	J. E. Cheadle	H6-60

HNF-EP-0182
Revision 447

Number of copies	Address	Mail Stop
1 electronic only	J. M. Colborn	H5-20
1 electronic only	E. M. Dawson	H6-60
1 electronic only	M. J. Demiter	H5-30
1 electronic only	R. M. Gordon	H6-60
1 electronic only	J. T. Greene	H5-20
1 electronic only	B. A. Harkins	H5-20
1 electronic only	P. R. Hernandez	H6-60
1 electronic only	C. Isackson	H6-60
1 electronic only	J. M. Johnson	H5-20
1 electronic only	T. M. Jones	H6-60
1 electronic only	K. K. Kidder	H5-20
1 electronic only	D. M. MacDonald	H5-20
1 electronic only	C. M. Meigs	H5-20
1 electronic only	E. N. Nelson	H5-20
1 electronic only	D. L. Noyes	H5-20
1 electronic only	M. S. Ornstein	H6-60
1 electronic only	C. R. Pacheco	H6-60
1 electronic only	J. M. Pesek	H6-60
1 electronic only	A. D. Peters	H6-60
1 electronic only	S. H. Pfaff	H5-30
1 electronic only	W. M. Ruane	william.ruane@hanford.gov
1 electronic only	P. A. Schroder	H5-20
1 electronic only	B. J. Stickney	H6-60
1 electronic only	B. Tamang	H5-20
1 electronic only	G. T. Tyree	H6-60
1 electronic only	R. J. Valle	H5-20
1 electronic only	B. T. Vance	H6-60
1 electronic only	A. J. Wiborg	H5-20
1 electronic only	K. L. Wong	H5-30
1 hard copy	Reading Room (P.H. McCormick)	H2-53
Office of the Inspector General		
1 electronic only	A. S. Nielsen	B8-27
1 electronic only	K. E. Otero-Hardgrove	B8-28
1 electronic only	L. J. Poppe	B8-27
1 electronic only	D. M. Thomas	B8-27
Hanford Tank Waste Operations & Closure, LLC		
Number of copies	Address	Mail Stop
1 electronic only	K. R. Bader	H1-60
1 hard copy	D. G. Baide	M4-30
1 electronic only	H. L. Baune	M4-30
1 electronic only	K. R. Beaulaurier	S5-08
1 electronic only	W. H. Bryan	S5-60
1 electronic only	S. T. Campbell	M4-30
1 electronic only	T. M. Crane	S5-08
1 electronic only	M. S. Cuttlers	S5-08
1 electronic only	J. S. Decker	jay_s_decker@rl.gov
1 electronic only	J. R. Dobson	S7-95
1 electronic only	B. K. Everett	S5-08
1 electronic only	K. D. Frisby	S5-08
1 electronic only	C. T. Hamon	H1-60
1 electronic only	D. J. Haynie	S7-81
1 electronic only	D. J. Henderson	M3-22
1 electronic only	M. L. Hendrickson	H1-60

HNF-EP-0182
Revision 447

Number of copies	Address	Mail Stop
1 electronic only	L. J. Hollick	M3-21
1 electronic only	D. J. Houghton	H1-60
1 electronic only	R. J. Houghton	M0-02
1 electronic only	A. G. Isherwood	S5-63
1 electronic only	M. R. Kembel	R2-58
1 electronic only	N. W. Kirch	M4-30
1 electronic only	J. L. Lucas	H3-22
1 electronic only	M. T. Lutz	S5-08
1 electronic only	M. H. McGrath	M4-30
1 electronic only	M. McKenna	A7-01
1 electronic only	A. G. Miskho	H1-60
1 electronic only	M. A. Molina	H1-60
1 electronic only	T. G. Myer	H1-60
1 electronic only	A. R. Olander	S7-90
1 electronic only	B. R. Piepenbring	M4-30
1 electronic only	A. H. Purvis	T4-70
1 hard copy	M. J. Rodgers	M4-30
1 electronic only	J. S. Rodriguez	S5-14
1 electronic only	R. M. Russell	S5-31
1 electronic only	B. C. Sanders	M1-42
1 electronic only	R. S. Scott	H1-51
1 electronic only	J. A. Slahtasky	T4-70
1 hard copy	D. W. Strasser	S5-63
1 electronic only	K. H. Subramanian	H4-30
1 electronic only	R. L. Swallow	S5-23
1 electronic only	B. R. Vuorenne	H1-60
1 electronic only	K. J. Way	R1-09
1 electronic only	R. Woodworth	G1-62
1 electronic only	E. I. Yokuda	R1-07
1 hard copy	WFO Shift Office	S5-08
1 electronic only	Environmental Data Mgmt Center	H6-08

Washington State Department of Ecology

Number of copies	Address	Mail Stop
1 electronic only	D. Desimone	dave.desimone@ecy.wa.gov
1 hard copy	J. J. Lyon	H0-57
1 hard copy	M. C. Merker	H0-57
1 electronic only	S. Needles	steve.needles@ecy.wa.gov

Pacific Northwest National Laboratory

Number of copies	Address	Mail Stop
1 electronic only	S. T. Arm	K9-89
1 electronic only	C. L. Bottenus	K9-89
1 electronic only	B. C. Simpson	K7-76
1 electronic only	M. A. Pelton	K7-76

Bechtel National, Inc.

Number of copies	Address	Mail Stop
1 electronic only	J. Fennell	jfennell@bechtel.us